



**HAL**  
open science

# Activation characteristic of a vibro-impact energy sink and its application to chatter control in turning

Tao Li, Donghai Qiu, Sébastien Seguy, Alain Berlioz

► **To cite this version:**

Tao Li, Donghai Qiu, Sébastien Seguy, Alain Berlioz. Activation characteristic of a vibro-impact energy sink and its application to chatter control in turning. *Journal of Sound and Vibration*, 2017, 405, pp.1-18. 10.1016/j.jsv.2017.05.033 . hal-01819565

**HAL Id: hal-01819565**

**<https://insa-toulouse.hal.science/hal-01819565v1>**

Submitted on 3 Dec 2018

**HAL** is a multi-disciplinary open access archive for the deposit and dissemination of scientific research documents, whether they are published or not. The documents may come from teaching and research institutions in France or abroad, or from public or private research centers.

L'archive ouverte pluridisciplinaire **HAL**, est destinée au dépôt et à la diffusion de documents scientifiques de niveau recherche, publiés ou non, émanant des établissements d'enseignement et de recherche français ou étrangers, des laboratoires publics ou privés.

1  
2  
3  
4  
5  
6  
7  
8  
9  
10  
11  
12  
13  
14  
15  
16  
17  
18  
19  
20  
21  
22  
23

# Activation characteristic of a vibro-impact energy sink and its application to chatter control in turning

24  
25  
26  
27  
28  
29  
30  
31  
32  
33  
34  
35  
36  
37  
38  
39  
40  
41  
42  
43  
44

T. Li\*, D. Qiu, S. Seguy, A. Berlioz

45  
46  
47  
48  
49

*Institut Clément Ader (ICA), CNRS-INSa-ISAIE-Mines Albi-UPS, Université de Toulouse, 3 rue  
Caroline Aigle, 31400, Toulouse, France*

---

## Abstract

50  
51  
52  
53  
54  
55  
56  
57  
58  
59  
60  
61  
62  
63  
64  
65

The ultimate goal of this paper is to propose a procedure for the optimal design of a Vibro-Impact (VI) Nonlinear Energy Sink (NES) to control the vibration of any possible linear or nonlinear main systems. To this end, the activation characteristic of VI NES at a range of displacement amplitude of a main system is generalized from linear systems to nonlinear systems. It is theoretically proved and experimentally observed that this activation characteristic is almost independent of frequency, which provides direct proof for the effectiveness of VI NES in a broad frequency bandwidth. In terms of vibration control, this feature is very attractive and builds a bridge between linear and nonlinear systems. Then it is applied for the design of VI NES attached to nonlinear systems. In this way, the design of VI NES for a nonlinear system is simplified to the optimal design for a linear system, which is designed to be similar to this target nonlinear system. Because the latter can be analytically calculated, the proposed method is feasible from a quantitative perspective. Finally, this activation characteristic and a proposed design method are applied to control chatter in a turning process, and results prove its feasibility.

*Keywords:* Vibro-impact, Optimal design, Activation, Nonlinear system, Targeted energy transfer, Nonlinear energy sink, Impact damper

---

\*Corresponding author

*Email addresses:* tli@insa-toulouse.fr (T. Li), qiu@insa-toulouse.fr (D. Qiu), sebastien.seguy@insa-toulouse.fr (S. Seguy), alain.berlioz@univ-tlse3.fr (A. Berlioz)

1  
2  
3  
4  
5  
6  
7  
8  
9 **1. Introduction**

10  
11 In engineering, clearance is common for structures such as linkage, gear train  
12 and joint. Impacts come into being when two objects contact, and can result in  
13 energy transfer and dissipation. This phenomenon is applied to vibration control  
14 since seventy years ago [1] and an auxiliary device is termed as impact damper.  
15 Later, there are extensive studies around impact damper and its dynamics as a  
16 typical vibro-impact system [2, 3]. The focus here is put on some recent studies  
17 since they are tightly related to the work of this paper.  
18

19  
20 Recently, impact damper is re-examined under the context of Targeted En-  
21 ergy Transfer (TET) [4, 5] and called Vibro-Impact (VI) Nonlinear Energy Sink  
22 (NES) [6, 7, 8]. The main advance comes from the analytical study of underlying  
23 Hamiltonian system [9] and the application of multiple scales method [10]. Con-  
24 sequently, special orbits that lead to TET are found from the former, and a Slow  
25 Invariant Manifold (SIM) that controls the variation of resonance captures are ob-  
26 tained from the latter. Some following analytical and numerical studies reveal  
27 further information about the complicated dynamics of this VI system, especially  
28 Strongly Modulated Response (SMR) [11, 12] and bifurcation analysis from the  
29 perspective of impact time difference [13].  
30  
31

32  
33 In addition to the explanation of its dynamics, there are also many researches  
34 about its characteristic as a damper. In general, two aspects of study results are  
35 obtained [8, 9], namely activation characteristic and parameter optimization. In  
36 terms of activation, VI NES is observed to respond fast at an initial stage when a  
37 main system is perturbed, and it is effective in a broad frequency range from the  
38 results of frequency spectrum analysis. With respect to parameter design, many  
39 suggestions are proposed, for example a medium clearance is better. Around these  
40 two aspects, it is found that the impact number per cycle of a main system matters  
41 for energy transfer and dissipation [14]. Then, the efficiency of different response  
42 regimes with different impact number per cycle is compared in [15], and it is  
43 found that the limit between response with permanent two impacts per cycle and  
44 that with intermittent two impacts per cycle (SMR) is optimal. Its essence behind  
45 is transient resonance captures with two impacts per cycle. This conclusion also  
46 holds for a linear system coupled with two VI NES in parallel [16]. In [15], there  
47 is another interesting phenomenon, just a range of clearance will be effective for  
48 a fixed outside excitation. Equivalently, a fixed clearance will only be effective in  
49 a displacement amplitude range of a main system [16].  
50  
51

52 This feature is very interesting in terms of vibration control and is very special  
53 as a NES. In [17], this kind of characteristic is also tried to be designed for a  
54  
55  
56  
57  
58

1  
2  
3  
4  
5  
6  
7  
8  
9 nonlinear vibration absorber but in a general way. Its basic philosophy of design  
10 can be reflected by the response regime with two impacts per cycle of systems  
11 coupled with VI NES.  
12

13 Whether this effective activation of VI NES only depends on the displacement  
14 amplitude and has nothing to do with frequency? If the answer is positive, it could  
15 be applied as a design criterion for VI NES to control the vibration of nonlinear  
16 systems at some displacement levels. Its benefit is evident since it maybe impos-  
17 sible to get reliable results from analytical studies of nonlinear systems coupled  
18 with VI NES, and the above-mentioned idea may provide a feasible solution.  
19

20 The difficulty of the application of NES to control vibration is already ob-  
21 served. For example, VI NES is attached to a cutting tool to quench its chatter  
22 in [18]. Experimental results demonstrate that an appropriately designed VI NES  
23 can effectively reduce the vibration of a cutting tool. However, its analytical de-  
24 velopment is based on a simplified equation and still has a distance to predict real  
25 responses, which is the same case for a turning system coupled with a cubic NES  
26 [19]. The problem is the same for a helicopter [20, 21]. Considering the difficulty  
27 of analytical study for any nonlinear systems coupled with VI NES, the possibil-  
28 ity to apply its activation characteristic and to simplify its design for nonlinear  
29 systems will be explored.  
30

31 The paper is organized as follows. In Section 2, a theoretical analysis for  
32 the activation characteristic of VI NES is presented. In Section 3 and 4, this  
33 activation characteristic is validated by numerical and experimental results from  
34 different linear and nonlinear main systems, respectively. In Section 5, a design  
35 procedure of VI NES is proposed and applied to control chatter in turning. Finally,  
36 conclusion is addressed.  
37  
38  
39  
40

## 41 42 **2. Analytical treatment**

43  
44 In essence, the analytical development here is similar to that of former studies  
45 [10, 11, 14], but some important information of SIM is neglected and will be  
46 further analyzed.  
47

### 48 49 *2.1. Analytical formulation*

50  
51 [Fig. 1 about here.]  
52

53 A LO under periodic excitation and coupled with a VI NES is showed in Fig. 1.  
54 Its motion between impacts is described by the following equation:  
55  
56  
57

$$\begin{aligned}
\ddot{x} + \varepsilon \lambda_1 \dot{x} + x &= \varepsilon G \sin \Omega \tau + \varepsilon^2 \lambda_1 G \Omega \cos \Omega \tau \\
\varepsilon \ddot{y} &= 0 \\
\forall |x - y| &< b
\end{aligned} \tag{1}$$

Parameters are expressed as follows:

$$\begin{aligned}
\varepsilon &= \frac{m_2}{m_1}, \quad \omega_0^2 = \frac{k_1}{m_1}, \quad f_0 = \frac{\omega_0}{2\pi}, \quad \tau = \omega_0 t, \\
\lambda_1 &= \frac{c_1}{m_2 \omega_0}, \quad \Omega = \frac{\omega}{\omega_0}, \quad G = \frac{F}{\varepsilon}
\end{aligned}$$

where  $x$ ,  $m_1$ ,  $c_1$  and  $k_1$  are the displacement, mass, damping and stiffness of LO, respectively.  $y$  and  $m_2$  represent displacement and mass of VI NES, respectively. Dots denote differentiation with respect to dimensionless time  $\tau$ .  $b$  represents the clearance.  $x_e(t)$  is the displacement imposed on the base by a shaker.  $\varepsilon G \sin \Omega \tau$  and  $\varepsilon^2 \lambda_1 G \Omega \cos \Omega \tau$  represent the force contribution of displacement and that of velocity by outside excitation, respectively. The latter term is conserved here to demonstrate its physical meaning and is neglected during the following analysis because of its small magnitude.

When  $|x - y| = b$ , impacts occur. The relation between after and before impact is obtained under the hypothesis of simplified shock theory and the condition of momentum conservation:

$$\begin{aligned}
x^+ &= x^-, \quad y^+ = y^- \\
\dot{x}^+ + \varepsilon \dot{y}^+ &= \dot{x}^- + \varepsilon \dot{y}^-, \quad \dot{x}^+ - \dot{y}^+ = -r(\dot{x}^- - \dot{y}^-), \\
\text{for } |x - y| &= b
\end{aligned} \tag{2}$$

where  $r$  is the restitution coefficient, and the superscripts  $+$  and  $-$  indicate the time immediately after and before impact. New variables representing the displacement of the center of mass and the internal displacement of VI NES are introduced:

$$v = x + \varepsilon y, \quad w = x - y \tag{3}$$

Substituting Eq. (3) into Eqs. (1) and (2), the equation between impacts in barycentric coordinate is given as:

1  
2  
3  
4  
5  
6  
7  
8  
9  
10  
11  
12  
13  
14  
15  
16  
17  
18  
19  
20  
21  
22  
23  
24  
25  
26  
27  
28  
29  
30  
31  
32  
33  
34  
35  
36  
37  
38  
39  
40  
41  
42  
43  
44  
45  
46  
47  
48  
49  
50  
51  
52  
53  
54  
55  
56  
57  
58  
59  
60  
61  
62  
63  
64  
65

$$\begin{aligned} \ddot{v} + \varepsilon \lambda_1 \frac{\dot{v} + \varepsilon \dot{w}}{1 + \varepsilon} + \frac{v + \varepsilon w}{1 + \varepsilon} &= \varepsilon G \sin \Omega \tau + \varepsilon^2 \lambda_1 G \Omega \cos \Omega \tau \\ \ddot{w} + \varepsilon \lambda_1 \frac{\dot{v} + \varepsilon \dot{w}}{1 + \varepsilon} + \frac{v + \varepsilon w}{1 + \varepsilon} &= \varepsilon G \sin \Omega \tau + \varepsilon^2 \lambda_1 G \Omega \cos \Omega \tau \\ \forall |w| < b \end{aligned} \quad (4)$$

and the impact condition (2) is rewritten as:

$$\begin{aligned} v^+ &= v^-, \quad w^+ = w^-, \\ v^+ &= \dot{v}^-, \quad \dot{w}^+ = -r \dot{w}^-, \quad \text{for } |w| = b \end{aligned} \quad (5)$$

Multiple scales are introduced in the following form:

$$\begin{aligned} v(\tau; \varepsilon) &= v_0(\tau_0, \tau_1, \dots) + \varepsilon v_1(\tau_0, \tau_1, \dots) + \dots \\ w(\tau; \varepsilon) &= w_0(\tau_0, \tau_1, \dots) + \varepsilon w_1(\tau_0, \tau_1, \dots) + \dots \\ \tau_k &= \varepsilon^k \tau, \quad k = 0, 1, \dots \end{aligned} \quad (6)$$

A detuning parameter ( $\sigma$ ) representing the nearness of the forcing frequency  $\Omega$  to the simplified natural frequency of LO is introduced:

$$\Omega = 1 + \varepsilon \sigma \quad (7)$$

Substituting Eqs. (6) and (7) into Eqs. (4) and (5), equating coefficients of like power of  $\varepsilon$  and only conserving the first two orders:

Order  $\varepsilon^0$ :

$$\begin{aligned} D_0^2 v_0 + v_0 &= 0 \\ D_0^2 w_0 + v_0 &= 0, \quad \forall |w_0| < b \end{aligned} \quad (8)$$

$$\begin{aligned} v_0^+ &= v_0^-, \quad w_0^+ = w_0^-, \\ D_0 v_0^+ &= D_0 v_0^-, \quad D_0 w_0^+ = -r D_0 w_0^-, \quad \text{for } |w_0| = b \end{aligned} \quad (9)$$

Order  $\varepsilon^1$ :

$$\begin{aligned} D_0^2 v_1 + v_1 &= -2D_0 D_1 v_0 - \lambda_1 D_0 v_0 - w_0 + v_0 \\ &+ G \sin(\tau_0 + \sigma \tau_1) \end{aligned} \quad (10)$$

where  $D_0$  represents partial derivative to time  $\tau_0$ . For order  $\varepsilon^1$ , only the term related to LO is conserved and will be used later. Combining the first order and the second one, both SIM and fixed points could be obtained. From the analysis

of order  $\varepsilon^0$ ,  $v_0$  represents an ideal undamped harmonic oscillator expressed as follows:

$$v_0 = C(\tau_1) \sin(\tau_0 + \theta(\tau_1)) \quad (11)$$

where  $C(\tau_1)$  and  $\theta(\tau_1)$  are its amplitude and phase, respectively. From the standpoint of  $w_0$ , Eq. 8 and Eq. 9 represent a harmonically forced impact oscillator with symmetric barrier. For the response regime (1 : 1 resonance) with two impacts per cycle, its solution can be searched in the following form:

$$w_0 = C(\tau_1) \sin(\tau_0 + \theta(\tau_1)) + \frac{2}{\pi} B(\tau_1) \Pi(\tau_0 + \eta(\tau_1)) \quad (12)$$

where  $B(\tau_1)$  and  $\eta(\tau_1)$  are displacement amplitude and phase of VI NES, respectively.  $\Pi(z)$  is a non-smooth sawtooth function [22]. This folded function and its derivative are depicted in Fig. 2 and expressed as follows:

[Fig. 2 about here.]

$$\Pi(z) = \arcsin(\sin z), \quad M(z) = \frac{d\Pi}{dz} = \text{sgn}(\cos z) \quad (13)$$

According to Eqs. (12) and (13), impact occurs at  $T_0 = \pi/2 - \eta + j\pi$  with  $j = 0, 1, 2, \dots$ . The impact condition  $|w_0| = b$  is rewritten with Eq. (12) as:

$$C \cos(\eta - \theta) = b - B \quad (14)$$

Rewriting now the inelastic impact condition Eq. (9) yields:

$$C(1+r) \sin(\eta - \theta) = \frac{2}{\pi} B(1-r) \quad (15)$$

Combining Eqs. (14) and (15), a relation between  $B$  and  $C$  is obtained as follows:

$$C^2 = \left( 1 + \frac{4(1-r)^2}{\pi^2(1+r)^2} \right) B^2 - 2bB + b^2 \quad (16)$$

An example of SIM described by Eq. (16) with  $b = 1$  and  $r = 0.6$  is presented in Fig. 3. The stability of SIM is analyzed by an asymptotic approach used in [11] that is originally applied in [23, 24]. By this stable analysis method, the stable branch is defined by the condition that the modulus of all the eigenvalues of

a certain matrix relating two consecutive impacts is less than unity. This stability analysis can also be accomplished by direct numerical integration of Eqs. (8) and (9).

[Fig. 3 about here.]

In order to obtain fixed points or study the non-stationary evolution of the motion of the system on the SIM, i.e., the analysis of transient resonance captures under transient excitation and transient resonance captures of SMR, Eq. (10) at the next order of approximation is analyzed. To identify terms that produce secular terms, the function of  $w_0$  is expanded in Fourier series:

$$w_0 = C(\tau_1) \sin(\tau_0 + \theta(\tau_1)) + E(\tau_1) \sin(\tau_0 + \zeta(T_1)) + \text{RFC} \quad (17)$$

where RFC represents the rest components in addition to the simplified natural frequency of LO. The component  $C(\tau_1)$  is decided by the motion of LO and  $E(\tau_1)$  is totally related to the motion of VI NES. The value of  $E(\tau_1)$  is related to the periodic impact force. The Eq. (17) is a more general and relaxed analytical description with respect to the motion of VI NES compared to former studies [10, 11] that consider only 1:1 resonance with two symmetric impacts per cycle.

Substituting Eqs. (11), (12) and (17) into Eq. (10) and eliminating terms that produce secular terms give:

$$\begin{aligned} D_1 C &= -\frac{1}{2} \lambda_1 C - \frac{1}{2} E \sin(\Theta) + \frac{1}{2} G \sin(\eta) \\ D_1 \eta &= \frac{1}{2} G \cos(\eta) / C - \frac{1}{2} E \cos(\Theta) / C + \sigma \end{aligned} \quad (18)$$

where

$$\begin{aligned} \Theta &= \zeta - \theta \\ \eta &= \sigma \tau_1 - \theta \end{aligned} \quad (19)$$

$\Theta$  represents the phase difference related to LO and VI NES.  $\eta$  represents the phase difference related to LO and outside excitation.

The fixed points can be obtained by equating the left side of Eq. (18) to zero and then combining it with Eq. (16). In this way, the fixed points (number and position) can be obtained. Compared to the classic non-asymptotic method, the functionality of this asymptotic method is twofold. Firstly, the position of points can be used to judge the type of response regime. Secondly, values can be precisely calculated for 1:1 resonance, which is related to optimal response regime



1  
2  
3  
4  
5  
6  
7  
8  
9 [15]. Meanwhile, the corresponding equivalent force  $E$  between LO and VI NES  
10 can be used to analyze their underlying dynamic performance.  
11

## 12 2.2. Analysis of SIM 13

14 For a fixed point in SIM as showed in Fig. 3,  $C$  and  $B$  represent the displace-  
15 ment amplitude related to LO and VI NES, respectively. After a dimensionless  
16 process, these two parameters remain the same. However, the frequency of LO  
17 is normalized and the velocity of VI NES is also scaled. It means that one point  
18 of SIM actually represents different response regimes which have the same ratio  
19 between  $C$  and  $B$  but possess different frequencies. Different points of SIM  
20 represent different responses with different ratios of displacement amplitude and  
21 they together represent all possible response regimes. Here, one important point  
22 that different systems coupled with a same VI NES can have the same SIM is ne-  
23 glected during all former studies, because these former studies are carried out for  
24 different systems case by case.  
25

26 In [15], it is found that a VI NES with a specific clearance will only be effec-  
27 tive in a range of displacement amplitude of LO. Actually, this is related to the  
28 blue stable branch of SIM in Fig. 3. Theoretically, VI NES with a fixed clearance  
29 should be activated at a fixed displacement amplitude interval for different LO  
30 with different natural frequencies. Then, whether it still holds for nonlinear sys-  
31 tems with varying frequency when its energy changes. If a considered nonlinear  
32 system at different energy levels can be equivalent to different linear systems with  
33 different frequencies, the above activation characteristic can still be used. The  
34 essence behind is to find the activation condition of VI NES. In this way, the dif-  
35 ficulty of analytical treatment of system coupled with VI NES during the design  
36 process can be avoided.  
37

38 To design VI NES for vibration control of a nonlinear system, actually it is  
39 difficult to get the full information of this nonlinear system, let alone to treat this  
40 coupled system analytically. However, its range of work displacement amplitude  
41 is normally known in advance or can be obtained from a design objective. From  
42 the above analysis, it is exactly what needed for the optimal or relatively optimal  
43 design of VI NES.  
44

## 45 2.3. A design procedure for VI NES coupled to nonlinear systems 46

47 For the design of a VI NES for the vibration control of a nonlinear system,  
48 the idea is simple and just to find a similar linear system to this nonlinear system,  
49 then to optimally design VI NES for this linear system. However, there are some  
50 requirements to assure VI NES still works for target nonlinear system. Firstly and  
51

1  
2  
3  
4  
5  
6  
7  
8  
9 at least, the amplitude of this linear system should be the same as that of nonlinear  
10 system. Secondly and unnecessarily, the frequency of this linear system should  
11 be designed the same as that of nonlinear system. If just a linear system is used to  
12 approximate this nonlinear system working in a range of displacement amplitude,  
13 usually only the amplitude range can be approximated by this linear system and  
14 the condition with same frequency cannot be met. This requires a prerequisite that  
15 VI NES will be activated at a range of amplitude and its activation is independent  
16 of frequency. This point will be investigated in the following section.

17  
18  
19 As a summary, the activation of VI NES as a damper is special from two  
20 perspectives. Firstly, a VI NES with a fixed clearance will only be effective in  
21 a range of displacement amplitude. It means that different clearances will be  
22 activated at different amplitudes of displacement as observed from experimental  
23 transient excitation results [16]. This characteristic is very important in the do-  
24 main of vibration control. The second characteristic is about its effectiveness in a  
25 broad frequency range. Former observations are based on the frequency spectrum  
26 analysis of a transient or periodic response, and this way is indirect. This time, its  
27 theoretical base is well demonstrated from the analysis of SIM.

### 3. Numerical observations

31  
32  
33  
34 To guarantee the above-mentioned design mechanism of VI NES for nonlin-  
35 ear systems, several aspects about activation characteristics of VI NES will be  
36 checked in this section. Firstly, critical points (i.e.,  $p_0$ ,  $p_1$  and  $p_2$ ) of SIM should  
37 have the same values for different linear or nonlinear systems with different fre-  
38 quencies under some same conditions. For this purpose, three linear systems with  
39 different natural frequencies and one Duffing system with cubic nonlinearity are  
40 numerically studied. Moreover, whether an optimal clearance of VI NES for one  
41 system is still optimal for other systems is investigated. Secondly, the proportional  
42 activation of VI NES with different clearances is experimentally examined.

#### 3.1. LO and Duffing systems

43  
44  
45  
46  
47  
48 Eq. (1) is modified to Eq. (20) in order to include a cubic term described by  $\alpha$ ,  
49 and a proportional factor  $\beta$  is introduced to regulate linear stiffness. The variation  
50 of  $\beta$  will be reflected in parameter  $\lambda_1$ . For moments of impact, Eq. (2) still applies.  
51 The meaning of other parameters is the same as those in the last section. Eqs. (20)  
52 and (2) will be combined for numerical simulation, and the following parameters  
53 are fixed except specially pointed out:  $\varepsilon = 0.84, r = 0.6$ .

1  
2  
3  
4  
5  
6  
7  
8  
9  
10  
11  
12  
13  
14  
15  
16  
17  
18  
19  
20  
21  
22  
23  
24  
25  
26  
27  
28  
29  
30  
31  
32  
33  
34  
35  
36  
37  
38  
39  
40  
41  
42  
43  
44  
45  
46  
47  
48  
49  
50  
51  
52  
53  
54  
55  
56  
57  
58  
59  
60  
61  
62  
63  
64  
65

$$\begin{aligned} \ddot{x} + \varepsilon \lambda_1 \dot{x} + x + \alpha x^3 &= \varepsilon G \sin \Omega \tau + \varepsilon^2 \lambda_1 G \Omega \cos \Omega \tau \\ \varepsilon \ddot{y} &= 0 \\ \forall |x - y| &< b \end{aligned} \tag{20}$$

where

$$\omega_0^2 = \frac{\beta k_1}{m_1}$$

### 3.2. Free vibration of LO with different natural frequencies

The following parameters and initial conditions are used:  $G = 0, \alpha = 0, b = 0.05, x_0 = 0.1, \dot{x}_0 = 0, y_0 = b, \dot{y}_0 = 0$ . The following three values  $\beta$  are consecutively chosen: 1, 0.75 and 0.5. The objective is to create three different linear systems.

The results are showed in Fig. 4. For  $\beta = 1$ , the displacement of LO and relative displacement are displayed in Figs. 4 (a) and (b), respectively. Then, two points and their values are marked out in Figs. 4 (c-d). They correspond to special points p0 and p2 in Fig. 3. Because the transition from regime with two asymmetric impacts per cycle to the symmetric case is difficult to distinguish, only p0 and p2 are used in the following results. In Fig. 4(e), corresponding value  $x$  of p0 and p2 for these three different  $\beta$  is compared. These two broken lines are the line fitting of numerical results. It is observed that the value  $x$  is almost the same for these three values of  $\beta$ .

[Fig. 4 about here.]

When parameters and initial conditions are fixed as:  $G = 0, \beta = 1, \alpha = 0, x_0 = 0.02, \dot{x}_0 = 0, y_0 = b, \dot{y}_0 = 0$ , different values of  $b$  are chosen to compare its efficiency for a same main system and  $b = 0.05$  is found to be optimal. Then this optimal value of  $b$  is applied to other systems with different  $\beta$ . The results are demonstrated in Fig. 5. The time history of displacement for  $\beta = 1$  is displayed in Fig. 5(a) and  $x$  related to p2 is marked out. The comparison between three different  $\beta$  is showed in Fig. 5(b). All three values are around 0.0052, which results in almost the same decay inclination for these three systems.

[Fig. 5 about here.]

1  
2  
3  
4  
5  
6  
7  
8  
9 3.3. *Free vibration of different Duffing systems*

10 For systems with cubic nonlinearity, the following parameters and initial con-  
11 ditions are used:  $G = 0, \alpha = 250000, \beta = 1, x_0 = 0.02, \dot{x}_0 = 0, y_0 = b, \dot{y}_0 = 0$ .  
12 Different values of  $b$  are chosen to compare their efficiency.  $x$  related to p2 are  
13 compared and showed in Fig. 6. It is observed that  $x$  for p2 is proportional to  
14  $b$ , and this characteristic will also be demonstrated in the following experimental  
15 results.  
16  
17  
18

19 [Fig. 6 about here.]  
20

21  
22 As a summary, it is numerically observed the proportional activation of VI  
23 NES to different clearances and the independence of its activation to the frequency  
24 of main systems.  
25

26  
27 **4. Experimental observations**  
28

29 The objective of this section is to verify the activation of VI NES from different  
30 experimental results under different excitations.  
31

32  
33 4.1. *Periodic excitation*

34 For periodic excitation, experiments for a LO coupled with a VI NES are the  
35 same as these in [15], in which specific information about experimental configu-  
36 ration and parameters can be found. Here, just the time history of displacement is  
37 demonstrated for a single frequency excitation at the first place, and for a range of  
38 frequency at the second place.  
39  
40

41  
42 4.1.1. *Single frequency excitation*

43 The whole time histories of displacement of LO for three different  $b$  is showed  
44 in Fig. 7 (a-c) , respectively. Judging from the time range 20 – 70 s, SMR occurs  
45 at this stable area, and the point of minimal amplitude related to p2 is marked out  
46 at the same time moment for all three of them. Its value denoted by  $Y$  is marked  
47 out. The relation between different  $b$  and its corresponding minimal amplitude  
48 is represented by blue circles in Fig. 7(d) and then is linearly interpolated. The  
49 consistency between the red broken line and circles proves the proportional activa-  
50 tion characteristic to some extent considering that the number of points is limited.  
51 However, this activation feature could be further observed from other viewpoints.  
52  
53  
54  
55

56 [Fig. 7 about here.]  
57  
58

1  
2  
3  
4  
5  
6  
7  
8  
9 *4.1.2. Excitation with a band of frequency*

10 To observe the proportional activation characteristic of VI NES, the amplitude  
11 of LO related to the limit point p2 in SIM, i.e., the corresponding response regime  
12 limit between SMR and two impacts per cycle, is recorded for different values of  
13  $b$  during the sweep process.  
14  
15

16 [Fig. 8 about here.]  
17  
18

19 The displacement amplitudes of LO are marked out for different  $b$  and showed  
20 in Fig. 8(a) and (b). The shift of resonance peak between different experimental  
21 results comes from the difference of the starting record time. The starting or end-  
22 ing points of the regime with two impacts per cycle are marked out for different  
23  $b$  and their specific judgment requires the data of acceleration. This judgment  
24 process will be demonstrated for the analysis of the following transient experi-  
25 mental results. It should be pointed out here that these marked points are enough  
26 to coarsely describe the difference caused by  $b$ , though it is difficult to accurately  
27 locate these points. Moreover, these two points entering into and leaving from the  
28 regime with two impacts per cycle is visible and distinguishable during the experi-  
29 mental process. As has been done before, these points are fitted by a red broken  
30 line as showed in Fig. 8(c). These points almost locate in a line and prove again  
31 the proportional activation characteristic.  
32  
33  
34  
35  
36

37 *4.2. Transient excitation*

38 The objective of transient experiments with different linear and nonlinear sys-  
39 tems is to study whether the activation of VI NES is related to frequency.  
40  
41

42 *4.2.1. Experimental configuration*

43 [Fig. 9 about here.]  
44  
45

46 In addition to the above experimental results under periodic excitation, three  
47 linear systems with different stiffness and one Duffing system are experimentally  
48 studied under transient excitation. The objective here is to observe the dependence  
49 of the activation behavior of VI NES on frequency. More specifically, it is to test  
50 that a VI NES with a same clearance will be excited at a same displacement range  
51 of a main system with different frequencies.  
52  
53

54 [Table 1 about here.]  
55  
56  
57  
58

1  
2  
3  
4  
5  
6  
7  
8  
9 The same mass and damping of oscillator, same VI NES as showed in Fig. 9  
10 will be used during the whole experimental process. Only the number of springs  
11 is changed from 4 to 3 or 2, or even the direction of springs is changed to create  
12 a Duffing system. The oscillator is installed to a cast iron bench, and its displace-  
13 ment and acceleration are measured by an acceleration sensor and a displacement  
14 sensor, respectively. The LO is detailed in Fig. 9(a) and its stiffness can be reg-  
15 ulated by modifying the number of springs in its two sides. A detailed view of  
16 the fixation of springs is displayed in Fig. 9(b), in which two springs are used. If  
17 only one spring is used, this spring will be attached to middle holes. During the  
18 experimental process, 4, 3 and 2 springs are consecutively applied. Their stiffness  
19 can be calculated according to the value of 4 springs as showed in Table 1. The  
20 device to regulate displacement is showed in Fig. 9(c) and the initial displacement  
21 of LO is set to around 20 mm for all tests. An enlarged view of VI NES is demon-  
22 strated in Fig. 9(d). Its initial location is random for all tests. The specific location  
23 is not so important, since only the stable process will be considered. In addition,  
24 the initial velocities of LO and VI NES are zero. A Duffing system is showed in  
25 Fig. 9(e). It should be pointed out that only the stiffness is different for the above  
26 four systems.  
27  
28  
29  
30  
31  
32

33 [Fig. 10 about here.]  
34

#### 35 4.2.2. *Experimental results* 36

37 The response for LO with 4 springs and  $b = 5$  mm is demonstrated in Fig. 10  
38 to illustrate the process to identify typical values related to two limit points  $p_0$   
39 and  $p_2$ . The first limit point is that between the regime with three impacts per  
40 cycle and that with two impacts per cycle, and the second is the one between the  
41 regime with two impacts per cycle and that with less than two impacts per cycle.  
42 The displacement is showed in Fig. 10(a), the first limit is between two points:  
43 the local maximum point A2 and minimum point A3. Similarly, the second limit  
44 point is between two other points: the local maximum point B2 and minimum  
45 point B3. The identification of these four points can be obtained from special  
46 points at the time history of acceleration in Fig. 10(b) and this identification is  
47 also used for the former periodic experimental results. Two periods are enlarged  
48 and displayed in Fig. 10(c) and (d). Point A1 is the last impact of periods with  
49 three impacts per cycle. Point B1 is the last impact of the regime with two impacts  
50 per cycle. According to values of A1 and B1, special points A2, A3, B2 and B3  
51 can be identified, and then corresponding displacement amplitudes of this main  
52 oscillator can be obtained, as showed in Fig. 10(a).  
53  
54  
55  
56  
57  
58

1  
2  
3  
4  
5  
6  
7  
8  
9 [Fig. 11 about here.]

10  
11 For different main systems with same displacement amplitude, its energy is  
12 bigger for a larger stiffness. For free vibration, there exist more oscillations during  
13 the decay process for the case with larger stiffness. Therefore, it will be clearer  
14 to see the transition process of different transient response regimes with a larger  
15 stiffness for the same VI NES, since the transition process of transient response is  
16 finer.  
17  
18

19  
20 [Fig. 12 about here.]  
21

22  
23 Then, amplitudes related to these two limit points  $p_0$  and  $p_2$  for four differ-  
24 ent main systems are compared and showed in Fig. 12. As showed in Fig. 12(a),  
25 the first three values in the horizontal axis represent LO with 4, 3 and 2 springs,  
26 respectively. The last value represents a Duffing system with 4 springs. The  
27 meaning of the horizontal axis is the same for other three subfigures. Two clear-  
28 ances  $b = 5$  mm and 10 mm are chosen and results are showed in Fig. 12(a-b)  
29 and Fig. 12(c-d), respectively. Broken lines are curve fittings of experimental data  
30 to show its variation trend. In Fig. 12(a), the results are obtained from positive  
31 amplitude of displacement, A2 and A3 illustrate the first and second limit points,  
32 respectively. The values of  $x$  are almost the same compared to its absolute value,  
33 which provides a direct proof that the activation characteristic of VI NES is inde-  
34 pendent of frequency. A small increase of value with the decrease of the number  
35 of springs is reasonable because the representation of transient responses by mea-  
36 sured data becomes coarse with the decrease of stiffness. As for the comparison  
37 between LO with 2 springs and Duffing system with 4 springs, the difference is  
38 not significant because that their stiffness are close and other unclear factors like  
39 friction may play a critical role in deciding this value.  
40  
41

42  
43 The same conclusion can be obtained from the analysis of points A3 and B3  
44 in the negative side of displacement as showed in Fig. 12(b). Moreover, results  
45 showed in Fig. 12(c-d) for  $b = 10$  mm also support the above analysis.  
46

47  
48 In summary, activation characteristic of VI NES is examined from experimen-  
49 tal viewpoints, and there are some credible results for its proportional activation.  
50 In addition, the dependence of its activation on frequency is explored by a tran-  
51 sient experiment. Although there are some results credible to some extent, they  
52 are not so ideal and it results from the fact that the frequency difference between  
53 these four systems is not large enough, meanwhile limit points  $p_0$  and  $p_2$  can not  
54 be truly accurately obtained for these four systems with low frequency.  
55  
56  
57  
58

## 5. Design of VI NES for chatter control

In this section, a design procedure of VI NES based on its activation characteristic will be applied to control the chatter of a cutting tool during a turning process. A simplified model and corresponding experimental parameters in [18] will be used. The application of VI NES has been experimentally observed to be efficient in quenching an unstable cutting in this paper. It is demonstrated that the bifurcation diagram is complex [25] and corresponding response regimes are also complex. Two typical cases will be chosen to demonstrate this optimization procedure. One case corresponds to an unstable cutting possessing a steady state response as well as a stable cutting with zero amplitude. The other case corresponds to an unstable cutting characterized by beating response.

### 5.1. Model of a cutting tool coupled with VI NES

[Fig. 13 about here.]

A simplified model of a cutting tool coupled with a VI NES is represented in Fig. 13. The cutting tool is supposed to only vibrate in the feed direction and the workpiece is considered rigid. The corresponding equation of motion between impacts is written as follows:

$$\begin{aligned} m_1\ddot{x} + c_1\dot{x} + k_1x + k_2x^3 &= F_x \\ F_x &= p(\rho_1\Delta h^1 + \rho_2\Delta h^2 + \rho_3\Delta h^3) \\ \varepsilon\ddot{y} &= 0 \\ \forall |x - y| &< b \end{aligned} \quad (21)$$

[Table 2 about here.]

Related parameters are expressed as follows:

$$\omega_0^2 = \frac{k_1}{m_1}, \quad f_1 = \frac{\omega_0}{2\pi}, \quad \mu_1 = \frac{c_1}{2m_2\omega_0} \quad (22)$$

where  $x$ ,  $m_1$ ,  $c_1$ ,  $k_1$  and  $k_3$  are the displacement, mass, damping, coefficient of linear stiffness and coefficient of cubic stiffness of the cutting tool, respectively.  $y$  and  $m_2$  are displacement and mass of VI NES. Dots denote the differentiation with respect to time  $t$ .  $\Delta h$  is decided by the current displacement and the displacement trajectory left by the last pass.  $b$  represents the clearance. When  $|x - y| = b$ , impacts occur. The relation between after and before impact is obtained under the



hypothesis of simplified shock theory and the condition of momentum conservation:

$$\begin{aligned}
 x^+ &= x^-, & y^+ &= y^- \\
 m_1 \dot{x}^+ + m_2 \dot{y}^+ &= m_1 \dot{x}^- + m_2 \dot{y}^-, \\
 \dot{x}^+ - \dot{y}^+ &= -r (\dot{x}^- - \dot{y}^-), \\
 \text{for } |x - y| &= b
 \end{aligned} \tag{23}$$

[Fig. 14 about here.]

## 5.2. Design of VI NES for different cases

Physical and cutting parameters are showed in Table 2. Only the cutting width  $h_0$  and clearance  $b$  will be varied. At first, the system is not coupled with VI NES and the cutting width is varied to see the bifurcation process. When  $h_0 = 0.11$  mm, a case with two fixed points is observed denoted as case 1 and another fixed point with beating response is located with  $h_0 = 0.16$  mm and is denoted as case 2. The response regimes for these two cases without and with VI NES will be demonstrated.

### 5.2.1. Case 1

For  $h_0 = 0.11$  mm, the following initial conditions are fixed and used:  $\dot{x}_0 = 0, y_0 = b, \dot{y}_0 = 0$ . Only initial displacement  $x_0$  is changed. When  $x_0$  is chosen to a large enough value such as 0.20 mm and 0.01 mm,  $x$  will be attracted to a same steady state, which corresponds to an unstable cutting as showed in Fig. 14(a) and (b), respectively. If the initial condition is small enough, the response will decay to zero as displayed in Fig. 14(c).

To design  $b$  for VI NES, the analytical results in Section 2 will be used. At first, a LO close to this cutting tool, i.e., with the same displacement amplitude, is created. In addition, the corresponding LO will possess other same characteristics as the cutting tool as many as possible. The frequency of outside excitation for this created linear oscillator is fixed to the experimentally obtained frequency  $f_0$  and its amplitude will be chosen in order that the displacement amplitude of LO will be the same as that of the cutting tool. Then  $b$  is designed to make the target displacement amplitude of LO locate in p2 of the corresponding SIM under periodic excitation and in p1 for transient excitation. For the cutting tool, its final steady state, i.e., a steady non-zero or zero amplitude, is applied to decide which points will be chosen.

1  
2  
3  
4  
5  
6  
7  
8  
9 [Fig. 15 about here.]

10  
11 For the first two initial conditions, response of the cutting tool is periodic  
12 and its amplitude is  $5.41 * 10^{-3}$  mm and  $b$  is chosen to p2. For the third initial  
13 condition, response is transient and its displacement amplitude at the starting point  
14  $2.199 * 10^{-3}$  mm is chosen to make it locate at p1. The effect with VI NES is  
15 demonstrated in Fig. 15. For the first two initial conditions, the unstable state  
16 is improved to a stable state and its vibration is completely controlled as showed in  
17 Fig. 15(a-b). Meanwhile, its transient process of energy dissipation is accelerated.  
18 This is the same case for the third initial condition as showed in Fig. 15(c).  
19  
20

### 21 5.2.2. Case 2

22  
23 [Fig. 16 about here.]

24  
25 Compared to case 1, a beating response occurs for  $h_0 = 0.16$  mm as repre-  
26 sented by the blue curve in Fig. 16(a). Its amplitude of displacement is not steady.  
27 If the relative maximal value of point T1 is chosen as the target to create LO, the  
28 estimated amplitude will be high, and the response should be designed accord-  
29 ing to p1 with a relative high clearance for VI NES. In return, it will be a little  
30 small for the relative minimal value of point T2, the response should be designed  
31 according to p2.  
32

33  
34 When the relative minimal value  $Y = 3.208 * 10^{-3}$  mm of T2 is chosen, the p1  
35 is used as the targeted point. The result is showed in Fig. 16(a) and the displace-  
36 ment of the cutting tool in red curve is almost zero in this case. When the relative  
37 maximal value  $Y = 1.14 * 10^{-2}$  mm of point T1 is chosen with p2 as the target.  
38 The result in red curve is showed in Fig. 16(c) and the displacement of cutting  
39 tool is greater with this  $b$ . The displacement of VI NES  $y$  for these two designed  
40 values are showed in Figs. 16(b) and (d), respectively. For the first value of  $b$ , VI  
41 NES is much more activated at the beginning. Once vibration is decreased to a  
42 little value, VI NES is no longer activated. For the second value in Fig. 16 (d),  
43 VI NES is also activated, but its vibration is not reduced as the first value and VI  
44 NES is just occasionally activated.  
45

46  
47  
48 In summary, the design procedure proposed for VI NES is feasible and effec-  
49 tive for unstable cuttings during turning process. It demonstrates the feasibility of  
50 relatively optimal design of VI NES for vibration control of nonlinear systems.  
51

## 52 6. Conclusion

53  
54  
55 In this paper, SIM obtained from analytical development of LO coupled with  
56 VI NES is further analyzed. Activation characteristic of VI NES as a damper is  
57

1  
2  
3  
4  
5  
6  
7  
8  
9 analyzed from SIM and applied for design of VI NES. Then, activation character-  
10 istic of VI NES is numerically and experimentally validated. Finally, a proposed  
11 design procedure of VI NES is applied to control the chatter during a turning  
12 process.  
13

14 Although SIM has been greatly analyzed during the analytical treatment of  
15 system coupled with VI NES, its relation to frequency is not clearly explained  
16 before. It is found that VI NES with a clearance will be activated in a fixed range  
17 of displacement amplitude of a main system. Moreover it will not be affected  
18 by the frequency of this main system. Two highlights are obtained. Firstly, the  
19 effectiveness of VI NES in a broad range of frequency of a main system can be  
20 viewed from another direct viewpoint, namely analytical viewpoint, and this idea  
21 is different from traditional perspectives. Secondly, each NES could possess its  
22 own characteristic and need special attention.  
23

24 The design procedure of VI NES for the chatter control of a turning process  
25 is just applied to demonstrate the way to design VI NES for vibration control of  
26 nonlinear systems. Therefore, this section appears short and needs further study  
27 later.  
28

29 In general, about the activation characteristic of VI NES obtained from analyt-  
30 ical analysis, the experimental results are general credible and prove the analytical  
31 results. But they are not so ideal, for example, when Duffing system is created, the  
32 stiffness of cubic term is so week that a significant change of frequency to assure  
33 comparison cannot be obviously observed.  
34  
35  
36  
37

### 38 **Acknowledgments**

39 The authors acknowledge the French Ministry of Science and the Chinese  
40 Scholarship Council [grant number: 201304490063] for their financial support.  
41  
42  
43  
44

### 45 **References**

- 46  
47 [1] P. Lieber, D. Jensen, An acceleration damper: development, design and some  
48 applications, *Trans. ASME* 67 (10) (1945) 523–530.  
49  
50 [2] R. A. Ibrahim, *Vibro-impact dynamics: modeling, mapping and applica-*  
51 *tions*, Vol. 43, Springer Science & Business Media, Berlin, 2009.  
52  
53 [3] V. I. Babitsky, *Theory of vibro-impact systems and applications*, Springer  
54 Science & Business Media, Berlin, 2013.  
55  
56  
57  
58

- 1  
2  
3  
4  
5  
6  
7  
8  
9 [4] Y. Lee, A. F. Vakakis, L. Bergman, D. McFarland, G. Kerschen, F. Nucera,  
10 S. Tsakirtzis, P. Panagopoulos, Passive non-linear targeted energy transfer  
11 and its applications to vibration absorption: a review, Proceedings of the In-  
12 stitution of Mechanical Engineers, Part K: Journal of Multi-body Dynamics  
13 222 (2) (2008) 77–134.  
14  
15  
16 [5] A. F. Vakakis, O. Gendelman, L. Bergman, D. McFarland, G. Kerschen,  
17 Y. Lee, Nonlinear targeted energy transfer in mechanical and structural sys-  
18 tems, Vol. 156, Springer Science & Business Media, Berlin, 2008.  
19  
20  
21 [6] F. Nucera, A. Vakakis, D. McFarland, L. Bergman, G. Kerschen, Targeted  
22 energy transfers in vibro-impact oscillators for seismic mitigation, Nonlinear  
23 Dynamics 50 (3) (2007) 651–677.  
24  
25  
26 [7] F. Nucera, F. Lo Iacono, D. McFarland, L. Bergman, A. Vakakis, Application  
27 of broadband nonlinear targeted energy transfers for seismic mitigation of a  
28 shear frame: Experimental results, Journal of Sound and Vibration 313 (1)  
29 (2008) 57–76.  
30  
31  
32 [8] I. Karayannis, A. Vakakis, F. Georgiades, Vibro-impact attachments as shock  
33 absorbers, Proceedings of the Institution of Mechanical Engineers, Part C:  
34 Journal of Mechanical Engineering Science 222 (10) (2008) 1899–1908.  
35  
36  
37 [9] Y. Lee, F. Nucera, A. Vakakis, D. McFarland, L. Bergman, Periodic or-  
38 bits, damped transitions and targeted energy transfers in oscillators with  
39 vibro-impact attachments, Physica D: Nonlinear Phenomena 238 (18) (2009)  
40 1868–1896.  
41  
42  
43 [10] O. Gendelman, Analytic treatment of a system with a vibro-impact nonlinear  
44 energy sink, Journal of Sound and Vibration 331 (2012) 4599–4608.  
45  
46  
47 [11] E. Gourc, G. Michon, S. Seguy, A. Berlioz, Targeted energy transfer un-  
48 der harmonic forcing with a vibro-impact nonlinear energy sink: Analytical  
49 and experimental developments, Journal of Vibration and Acoustics 137 (3)  
50 (2015) 031–008.  
51  
52 [12] O. Gendelman, A. Alloni, Dynamics of forced system with vibro-impact  
53 energy sink, Journal of Sound and Vibration 358 (2015) 301–314.  
54  
55  
56  
57  
58  
59  
60  
61  
62  
63  
64  
65

- 1  
2  
3  
4  
5  
6  
7  
8  
9 [13] T. Li, S. Seguy, A. Berlioz, On the dynamics around targeted energy transfer  
10 for vibro-impact nonlinear energy sink, *Nonlinear Dynamics* 87 (3) (2017)  
11 1453–1466.  
12  
13 [14] T. Li, S. Seguy, A. Berlioz, Dynamics of cubic and vibro-impact nonlinear  
14 energy sink: Analytical, numerical, and experimental analysis, *Journal of*  
15 *Vibration and Acoustics* 138 (3) (2016) 031–010.  
16  
17 [15] T. Li, S. Seguy, A. Berlioz, Optimization mechanism of targeted energy  
18 transfer with vibro-impact energy sink under periodic and transient exci-  
19 tation, *Nonlinear Dynamics* 87 (4) (2017) 2415–2433.  
20  
21 [16] T. Li, E. Gourc, S. Seguy, A. Berlioz, Dynamics of two vibro-impact nonlin-  
22 ear energy sinks in parallel under periodic and transient excitations, *Internation-*  
23 *al Journal of Non-Linear Mechanics* 90 (2017) 100 – 110.  
24  
25 [17] R. Vigué, G. Kerschen, Nonlinear vibration absorber coupled to a nonlin-  
26 ear primary system: a tuning methodology, *Journal of sound and Vibration*  
27 326 (3) (2009) 780–793.  
28  
29 [18] E. Gourc, S. Seguy, G. Michon, A. Berlioz, B. Mann, Quenching chatter in-  
30 stability in turning process with a vibro-impact nonlinear energy sink, *Jour-*  
31 *nal of Sound and Vibration* 355 (2015) 392–406.  
32  
33 [19] E. Gourc, S. Seguy, G. Michon, A. Berlioz, Chatter control in turning pro-  
34 cess with a nonlinear energy sink, in: *Advanced Materials Research*, Vol.  
35 698, Trans Tech Publ, 2013, pp. 89–98.  
36  
37 [20] E. Gourc, L. Sanches, G. Michon, V. Steffen, Post-critical analysis of ground  
38 resonance phenomenon: effect of stator asymmetry, *Nonlinear Dynamics*  
39 83 (1) (2016) 201–215.  
40  
41 [21] B. Bergeot, S. Bellizzi, B. Cochelin, Analysis of steady-state response  
42 regimes of a helicopter ground resonance model including a non-linear en-  
43 ergy sink attachment, *International Journal of Non-Linear Mechanics* 78  
44 (2016) 72–89.  
45  
46 [22] V. Pilipchuk, Closed-form solutions for oscillators with inelastic impacts,  
47 *Journal of Sound and Vibration* 359 (2015) 154–167.  
48  
49  
50  
51  
52  
53  
54  
55  
56  
57  
58  
59  
60  
61  
62  
63  
64  
65

1  
2  
3  
4  
5  
6  
7  
8  
9  
10  
11  
12  
13  
14  
15  
16  
17  
18  
19  
20  
21  
22  
23  
24  
25  
26  
27  
28  
29  
30  
31  
32  
33  
34  
35  
36  
37  
38  
39  
40  
41  
42  
43  
44  
45  
46  
47  
48  
49  
50  
51  
52  
53  
54  
55  
56  
57  
58  
59  
60  
61  
62  
63  
64  
65

[23] S. Masri, T. Caughey, On the stability of the impact damper, *Journal of Applied Mechanics* 33 (3) (1966) 586–592.

[24] C. Bapat, N. Popplewell, K. McLachlan, Stable periodic motions of an impact-pair, *Journal of Sound and Vibration* 87 (1) (1983) 19–40.

[25] A. H. Nayfeh, N. A. Nayfeh, Analysis of the cutting tool on a lathe, *Nonlinear Dynamics* 63 (3) (2011) 395–416.

### List of Tables

1	Experimental parameters [15] . . . . .	23
2	Simulation parameters for a cutting tool coupled with VI NES . . . . .	24

### List of Figures

1	Schema of a LO coupled with a VI NES under periodic excitation.	25
2	Representation of the non-smooth functions $\Pi(z)$ in blue thick line and $M(z)$ in black fine line and red dotted line. . . . .	26
3	SIM of VI NES: one stable branch in blue thin line and two unstable branches in red thick line with special points $p_0$ , $p_1$ and $p_2$ . . . . .	27
4	Comparison of $p_0$ and $p_2$ for a LO with different natural frequencies: (a) the time history of displacement $x$ ; (b) the time history of relative displacement $w$ ; (c) the judge of $p_0$ and $p_1$ from $w$ ; (d) the judge of $p_2$ from $w$ ; (e) $x$ related to $p_0$ and $p_2$ . . . . .	28
5	Application of an optimal $b$ from one specific LO to two other linear systems with different frequencies: (a) the time history of displacement of LO with $\beta = 1$ ; (b) $x$ related to $p_2$ for different $\beta$ . . . . .	29
6	$x$ related to $p_2$ and obtained from the response of a Duffing system with different $b$ for VI NES. . . . .	30
7	Proportional activation characteristic of VI NES reflected by $p_2$ of SIM: (a) $b = 32.5$ mm; (b) $b = 35$ mm; (c) $b = 40$ mm. . . . .	31
8	Proportional activation characteristic of VI NES reflected by $p_2$ of SIM from sweep experiment: (a) $b = 10$ mm, 15 mm, 20 mm and 25 mm; (b) $b = 27.5$ mm, 30 mm, 35 mm and 40 mm; (c) linear relation between $b$ and $x$ . . . . .	32

9	Experimental setup: (a) linear systems with 4, 3 or 2 springs ; (b) the fixation of springs; (c) the regulation device of initial displacement; (d) an enlarged view of VI NES; (e) the Duffing system with 4 springs. . . . .	33
10	LO with 4 springs and $b = 5$ mm: (a) the time history of displacement; (b) the time history of acceleration; (c) an enlarged view of the time history of acceleration around point A1; (d) an enlarged view of the time history of acceleration around point B1. . . . .	34
11	Duffing system with 4 springs and $b = 5$ mm: (a) the time history of displacement; (b) the time history of acceleration. . . . .	35
12	Amplitude of the main structure around points A2, A3, B2 and B3 for three linear systems with 4, 3 and 2 springs and a Duffing system with four springs and these four systems are presented by 1,2,3 and 4 in the horizontal axis, respectively: (a) A2 and B2 with $b = 5$ mm; (b) A3 and B3 with $b = 5$ mm; (c) A2 and B2 with $b = 10$ mm; (d) A3 and B3 with $b = 10$ mm. . . . .	36
13	Schema of a cutting tool system coupled with a VI NES. . . . .	37
14	Displacement of the cutting tool with different initial conditions for $h_0 = 0.11$ mm without VI NES: (a) $x_0 = 0.20$ mm; (b) $x_0 = 0.01$ mm; (c) $x_0 = 0.006$ mm. . . . .	38
15	Displacement of the cutting tool coupled with an effective VI NES for different initial conditions at $h_0 = 0.11$ mm: (a) $x_0 = 0.20$ mm and $b = 2.2880 * 10^{-2}$ mm; (b) $x_0 = 0.01$ mm and $b = 2.2880 * 10^{-2}$ mm; (c) $x_0 = 0.006$ mm and $b = 2.4604 * 10^{-3}$ mm. . . . .	39
16	Response comparison of the cutting tool without and with VI NES for $x_0 = 0.08$ mm and $h_0 = 0.16$ mm: (a) $x$ and $b = 1.3517 * 10^{-2}$ mm; (b) $y$ and $b = 1.3517 * 10^{-2}$ mm; (c) $x$ and $b = 1.2632 * 10^{-2}$ mm; (d) $y$ and $b = 1.2632 * 10^{-2}$ mm. . . . .	40

1  
2  
3  
4  
5  
6  
7  
8  
9  
10  
11  
12  
13  
14  
15  
16  
17  
18  
19  
20  
21  
22  
23  
24  
25  
26  
27  
28  
29  
30  
31  
32  
33  
34  
35  
36  
37  
38  
39  
40  
41  
42  
43  
44  
45  
46  
47  
48  
49  
50  
51  
52  
53  
54  
55  
56  
57  
58  
59  
60  
61  
62  
63  
64  
65

Table 1. Experimental parameters [15]

Physical Parameters			
$m_1$	4.7 kg	$c_1$	3.02 Ns/m
$k_1$	$11.47 * 10^3$ N/m	$m_2$	32 g
$b$	0 – 50 mm		
Reduced Parameters			
$\epsilon$	0.76 %	$\lambda_1$	1.91
$f_0$	7.86 Hz		

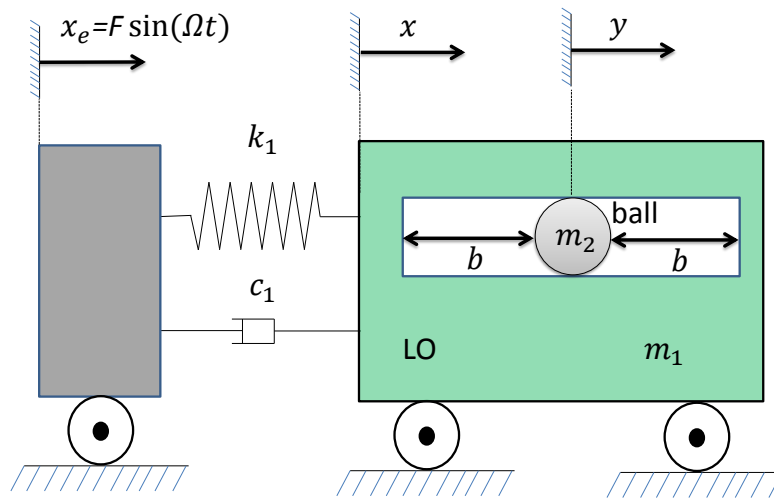


1  
2  
3  
4  
5  
6  
7  
8  
9  
10  
11  
12  
13  
14  
15  
16  
17  
18  
19  
20  
21  
22  
23  
24  
25  
26  
27  
28  
29  
30  
31  
32  
33  
34  
35  
36  
37  
38  
39  
40  
41  
42  
43  
44  
45  
46  
47  
48  
49  
50  
51  
52  
53  
54  
55  
56  
57  
58  
59  
60  
61  
62  
63  
64  
65

Table 2. Simulation parameters for a cutting tool coupled with VINES

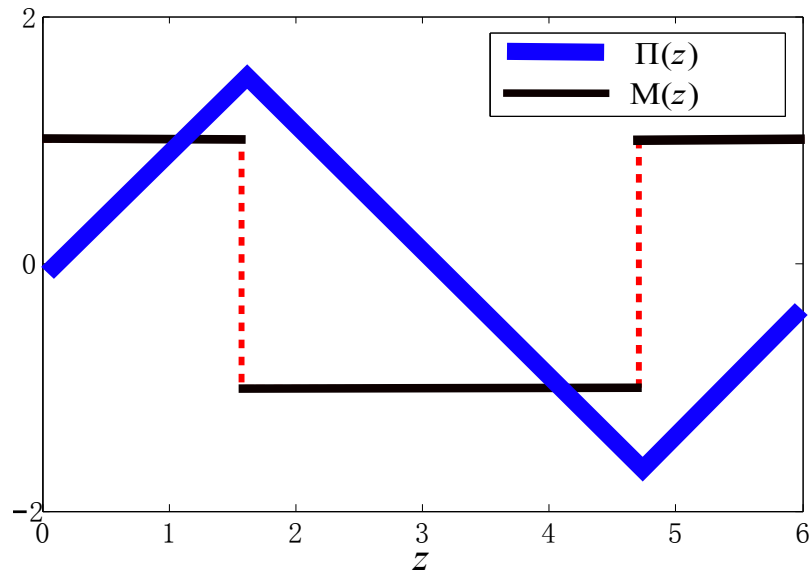
Physical Parameters			
$m_1$	3.1 kg	$\mu_1$	3%
$f_1$	99.4 Hz	$m_2$	32 g
$r$	0.6		
Cutting Parameters			
$p$	0.1 mm	$\rho_1$	$6109.6 * 10^6 \text{ Nm}^{-2}$
$\rho_2$	$-54141.6 * 10^9 \text{ Nm}^{-2}$	$\rho_3$	$203.769 * 10^{12} \text{ Nm}^{-2}$
$s$	1800 rpm		

1  
2  
3  
4  
5  
6  
7  
8  
9  
10  
11  
12  
13  
14  
15  
16  
17  
18  
19  
20  
21  
22  
23  
24  
25  
26  
27  
28  
29  
30  
31  
32  
33  
34  
35  
36  
37  
38  
39  
40  
41  
42  
43  
44  
45  
46  
47  
48  
49  
50  
51  
52  
53  
54  
55  
56  
57  
58  
59  
60  
61  
62  
63  
64  
65



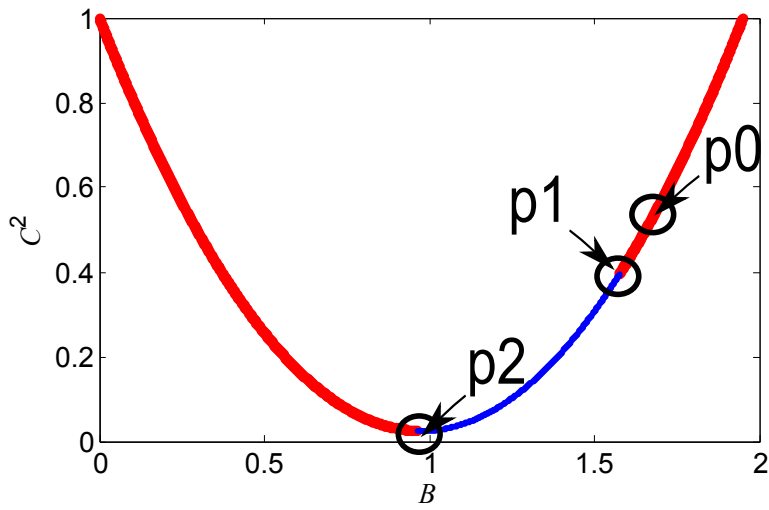
**Fig. 1.** Schema of a LO coupled with a VI NES under periodic excitation.

1  
2  
3  
4  
5  
6  
7  
8  
9  
10  
11  
12  
13  
14  
15  
16  
17  
18  
19  
20  
21  
22  
23  
24  
25  
26  
27  
28  
29  
30  
31  
32  
33  
34  
35  
36  
37  
38  
39  
40  
41  
42  
43  
44  
45  
46  
47  
48  
49  
50  
51  
52  
53  
54  
55  
56  
57  
58  
59  
60  
61  
62  
63  
64  
65



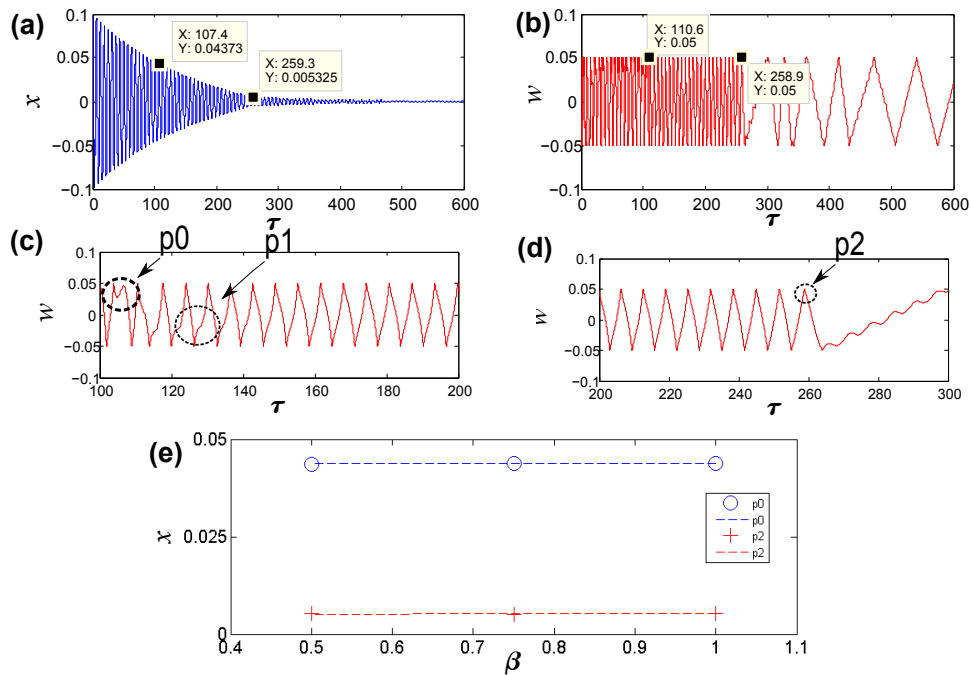
**Fig. 2.** Representation of the non-smooth functions  $\Pi(z)$  in blue thick line and  $M(z)$  in black fine line and red dotted line.

1  
2  
3  
4  
5  
6  
7  
8  
9  
10  
11  
12  
13  
14  
15  
16  
17  
18  
19  
20  
21  
22  
23  
24  
25  
26  
27  
28  
29  
30  
31  
32  
33  
34  
35  
36  
37  
38  
39  
40  
41  
42  
43  
44  
45  
46  
47  
48  
49  
50  
51  
52  
53  
54  
55  
56  
57  
58  
59  
60  
61  
62  
63  
64  
65

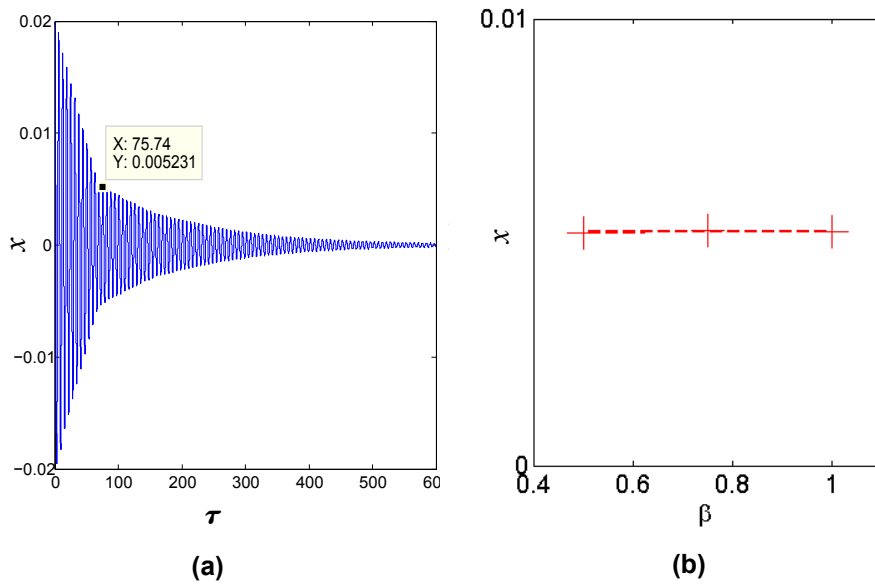


**Fig. 3.** SIM of VI NES: one stable branch in blue thin line and two unstable branches in red thick line with special points  $p_0$ ,  $p_1$  and  $p_2$ .

1  
2  
3  
4  
5  
6  
7  
8  
9  
10  
11  
12  
13  
14  
15  
16  
17  
18  
19  
20  
21  
22  
23  
24  
25  
26  
27  
28  
29  
30  
31  
32  
33  
34  
35  
36  
37  
38  
39  
40  
41  
42  
43  
44  
45  
46  
47  
48  
49  
50  
51  
52  
53  
54  
55  
56  
57  
58  
59  
60  
61  
62  
63  
64  
65

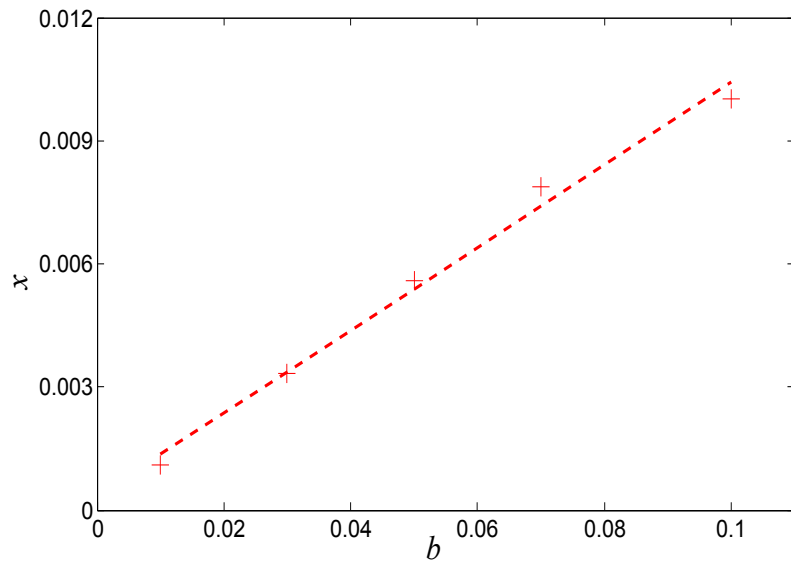


**Fig. 4.** Comparison of  $p_0$  and  $p_2$  for a LO with different natural frequencies: (a) the time history of displacement  $x$ ; (b) the time history of relative displacement  $w$ ; (c) the judge of  $p_0$  and  $p_1$  from  $w$ ; (d) the judge of  $p_2$  from  $w$ ; (e)  $x$  related to  $p_0$  and  $p_2$ .

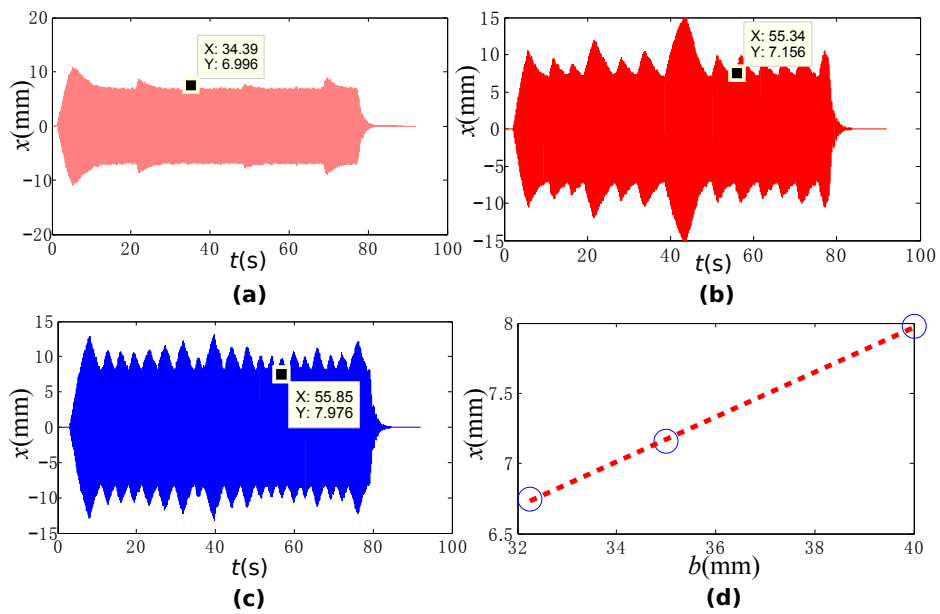


**Fig. 5.** Application of an optimal  $b$  from one specific LO to two other linear systems with different frequencies: (a) the time history of displacement of LO with  $\beta = 1$ ; (b)  $x$  related to  $p2$  for different  $\beta$ .

1  
2  
3  
4  
5  
6  
7  
8  
9  
10  
11  
12  
13  
14  
15  
16  
17  
18  
19  
20  
21  
22  
23  
24  
25  
26  
27  
28  
29  
30  
31  
32  
33  
34  
35  
36  
37  
38  
39  
40  
41  
42  
43  
44  
45  
46  
47  
48  
49  
50  
51  
52  
53  
54  
55  
56  
57  
58  
59  
60  
61  
62  
63  
64  
65

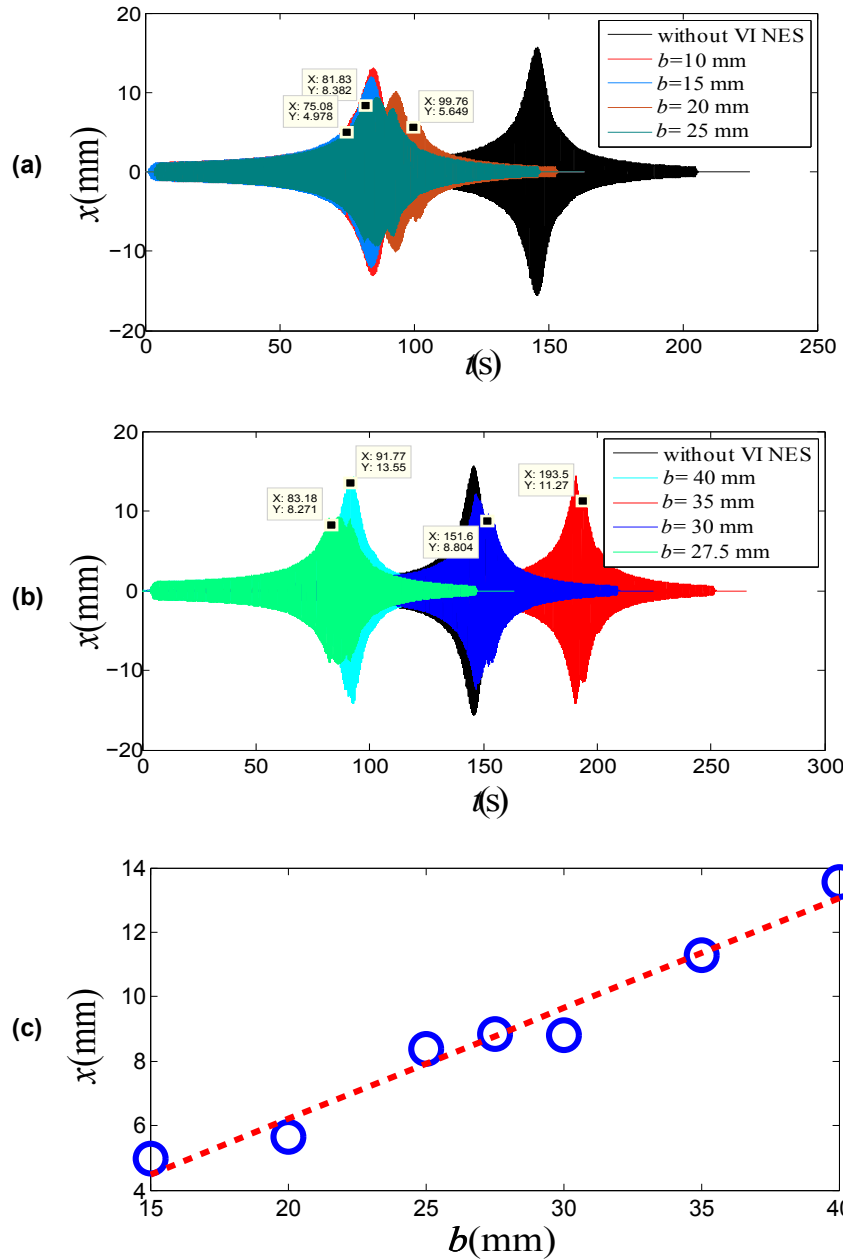


**Fig. 6.**  $x$  related to  $p_2$  and obtained from the response of a Duffing system with different  $b$  for VI NES.

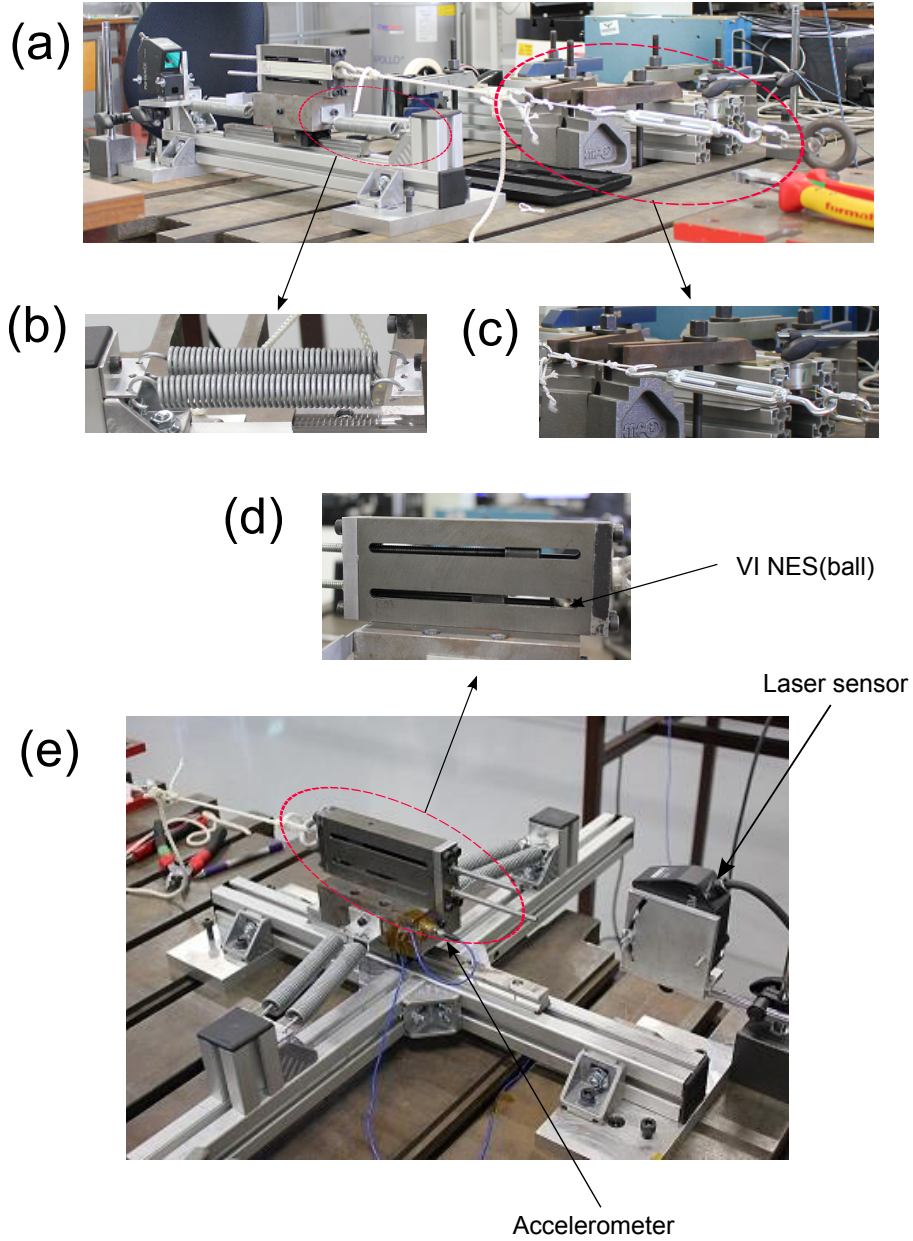


**Fig. 7.** Proportional activation characteristic of VI NES reflected by p2 of SIM: (a)  $b = 32.5$  mm; (b)  $b = 35$  mm; (c)  $b = 40$  mm.

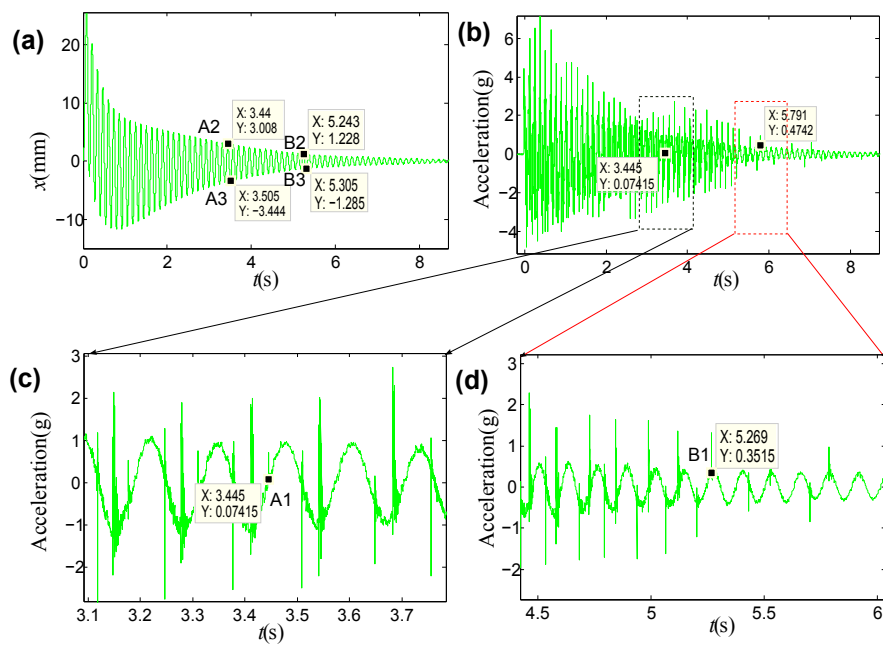




**Fig. 8.** Proportional activation characteristic of VI NES reflected by p2 of SIM from sweep experiment: (a)  $b = 10$  mm,  $15$  mm,  $20$  mm and  $25$  mm; (b)  $b = 27.5$  mm,  $30$  mm,  $35$  mm and  $40$  mm; (c) linear relation between  $b$  and  $x$ .

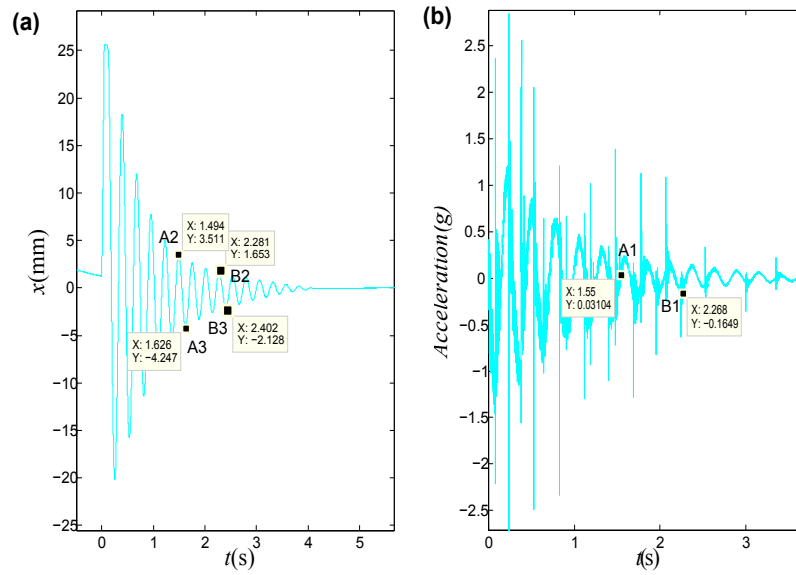


**Fig. 9.** Experimental setup: (a) linear systems with 4, 3 or 2 springs ; (b) the fixation of springs; (c) the regulation device of initial displacement; (d) an enlarged view of VI NES; (e) the Duffing system with 4 springs.



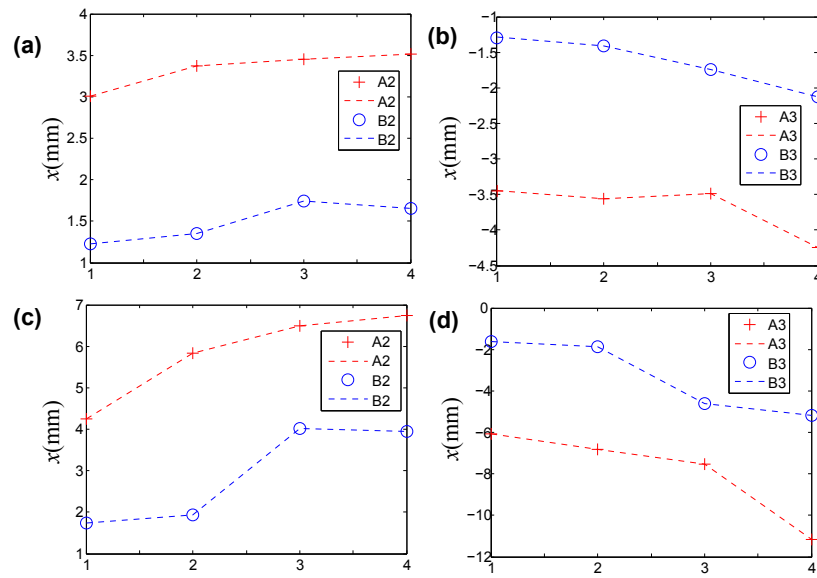
**Fig. 10.** LO with 4 springs and  $b = 5$  mm: (a) the time history of displacement; (b) the time history of acceleration; (c) an enlarged view of the time history of acceleration around point A1; (d) an enlarged view of the time history of acceleration around point B1.

1  
2  
3  
4  
5  
6  
7  
8  
9  
10  
11  
12  
13  
14  
15  
16  
17  
18  
19  
20  
21  
22  
23  
24  
25  
26  
27  
28  
29  
30  
31  
32  
33  
34  
35  
36  
37  
38  
39  
40  
41  
42  
43  
44  
45  
46  
47  
48  
49  
50  
51  
52  
53  
54  
55  
56  
57  
58  
59  
60  
61  
62  
63  
64  
65



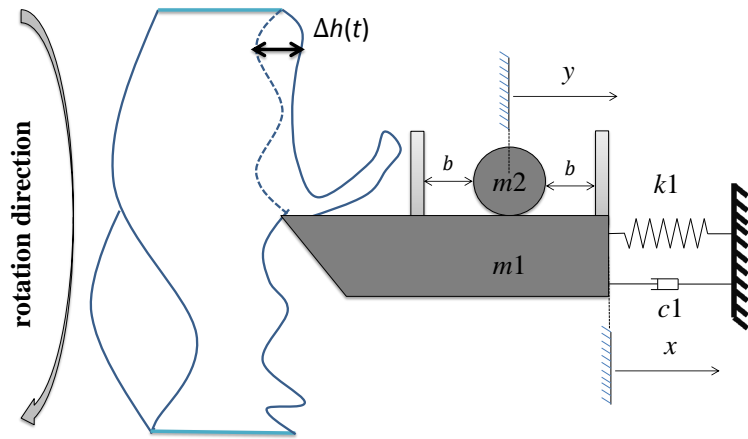
**Fig. 11.** Duffing system with 4 springs and  $b = 5$  mm: (a) the time history of displacement; (b) the time history of acceleration.

1  
2  
3  
4  
5  
6  
7  
8  
9  
10  
11  
12  
13  
14  
15  
16  
17  
18  
19  
20  
21  
22  
23  
24  
25  
26  
27  
28  
29  
30  
31  
32  
33  
34  
35  
36  
37  
38  
39  
40  
41  
42  
43  
44  
45  
46  
47  
48  
49  
50  
51  
52  
53  
54  
55  
56  
57  
58  
59  
60  
61  
62  
63  
64  
65



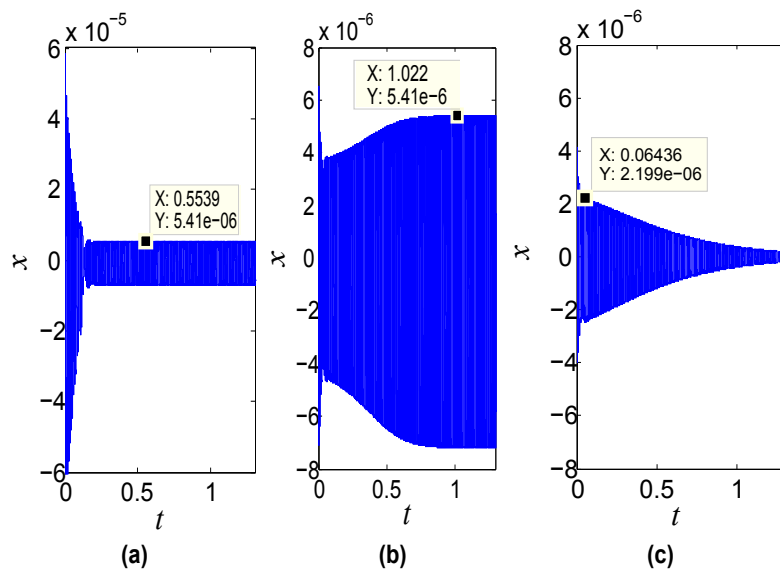
**Fig. 12.** Amplitude of the main structure around points A2, A3, B2 and B3 for three linear systems with 4, 3 and 2 springs and a Duffing system with four springs and these four systems are presented by 1,2,3 and 4 in the horizontal axis, respectively: (a) A2 and B2 with  $b = 5$  mm; (b) A3 and B3 with  $b = 5$  mm; (c) A2 and B2 with  $b = 10$  mm; (d) A3 and B3 with  $b = 10$  mm.

1  
2  
3  
4  
5  
6  
7  
8  
9  
10  
11  
12  
13  
14  
15  
16  
17  
18  
19  
20  
21  
22  
23  
24  
25  
26  
27  
28  
29  
30  
31  
32  
33  
34  
35  
36  
37  
38  
39  
40  
41  
42  
43  
44  
45  
46  
47  
48  
49  
50  
51  
52  
53  
54  
55  
56  
57  
58  
59  
60  
61  
62  
63  
64  
65

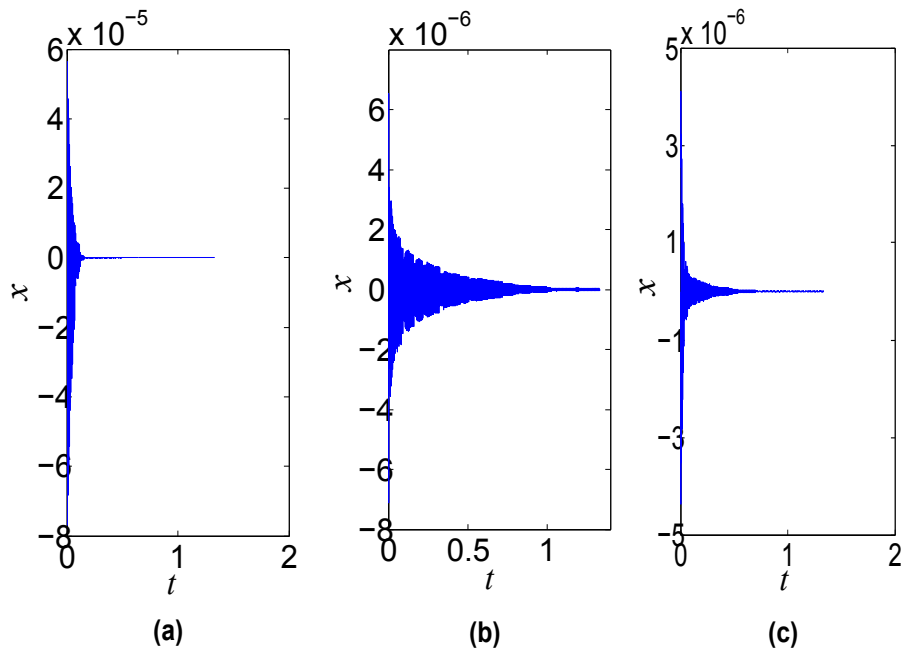


**Fig. 13.** Schema of a cutting tool system coupled with a VI NES.

1  
2  
3  
4  
5  
6  
7  
8  
9  
10  
11  
12  
13  
14  
15  
16  
17  
18  
19  
20  
21  
22  
23  
24  
25  
26  
27  
28  
29  
30  
31  
32  
33  
34  
35  
36  
37  
38  
39  
40  
41  
42  
43  
44  
45  
46  
47  
48  
49  
50  
51  
52  
53  
54  
55  
56  
57  
58  
59  
60  
61  
62  
63  
64  
65

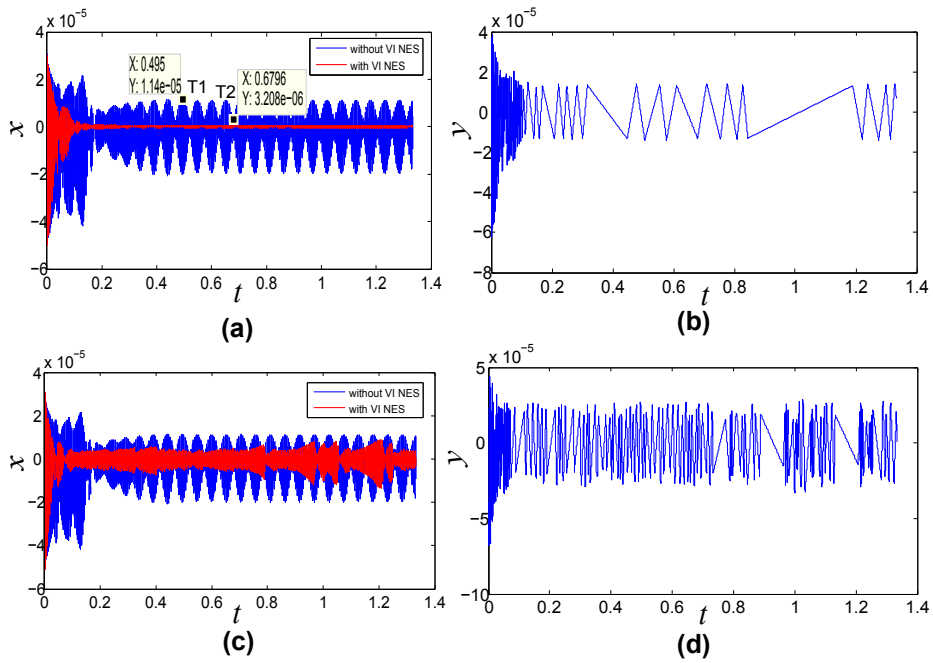


**Fig. 14.** Displacement of the cutting tool with different initial conditions for  $h_0 = 0.11$  mm without VINES: (a)  $x_0 = 0.20$  mm; (b)  $x_0 = 0.01$  mm; (c)  $x_0 = 0.006$  mm.



**Fig. 15.** Displacement of the cutting tool coupled with an effective VI NES for different initial conditions at  $h_0 = 0.11$  mm: (a)  $x_0 = 0.20$  mm and  $b = 2.2880 \times 10^{-2}$  mm; (b)  $x_0 = 0.01$  mm and  $b = 2.2880 \times 10^{-2}$  mm; (c)  $x_0 = 0.006$  mm and  $b = 2.4604 \times 10^{-3}$  mm.





**Fig. 16.** Response comparison of the cutting tool without and with VI NES for  $x_0 = 0.08$  mm and  $h_0 = 0.16$  mm: (a)  $x$  and  $b = 1.3517 \times 10^{-2}$  mm; (b)  $y$  and  $b = 1.3517 \times 10^{-2}$  mm; (c)  $x$  and  $b = 1.2632 \times 10^{-2}$  mm; (d)  $y$  and  $b = 1.2632 \times 10^{-2}$  mm.

Journal of Sound and Vibration

Author Checklist

Authors should complete the following checklist and submit with their revised manuscript.

Math notation follows requirements on Guide for Authors (GFA) see:

<https://www.elsevier.com/journals/journal-of-sound-and-vibration/0022-460X/guide-for-authors>

Use Roman (normal upright) type for: Total differential operators (e.g.  $d$  in differential);  $i$  or  $j$  (square root of  $-1$ );  $\exp$  or  $e$  (base of natural logarithms);  $\text{Re}$  or  $\text{Im}$  (real or imaginary part);  $\log$ ,  $\ln$ ,  $\sin$ ,  $\cos$ , etc.; abbreviations such as c.c. (complex conjugate); multiletter symbols (e.g. TL for transmission loss); subscripts of two or more letters identifiable as words or word-abbreviations (e.g.,  $A_{\text{pipe}}$ ,  $f_{\text{max}}$ )

For more unusual functions, JSV follows Abramowitz and Stegun's book. More detail given in the GFA (see link above).

Unit symbols - These should be upright (e.g. kg, not  $kg$ ).

All authors are listed on the manuscript with correct affiliations, correct email address and are in correct order.

Keywords present.

Manuscript is not currently submitted to any other Journal.

If submitting highlights please note that only six may be submitted and each one should be no longer than 85 characters in length.

Novelty of paper has been clearly stated in the Introduction.

References are presented as per GFA.

References not produced in English language to have English translation in brackets.

Figures and Tables and Equations are numbered in sequence correctly. (See GFA).

Nomenclature (if required) appears on second page of submission.

Acknowledgements appear in a separate section after the conclusion section but before references.

All abbreviations, in both the abstract and main body of document, are defined once only, the first time they appear in the text. (N.B. The Abstract is treated as an independent text, where references are given in full and abbreviations and symbols, if used, are properly defined.)

Figures – if there are multi-parts to a figures each part is labelled (a) (b) (c) etc. and the labels defined in the figure caption.

Figures – Colour can be used for the on-line version. Figures are reproduced in black and white in the printed journal and must therefore be readable in both colour and black & white. (N.B. charges apply for production of colour figures in the printed journal)

Appendices – should appear before the list of references and labelled A, B, C, (please see GFA for further information regarding equations, figures and tables in the appendices).

Copyright – material reproduced from other publications (e.g. Tables, Figures), source is acknowledged.

Statement of Author contribution complete (see GFA)