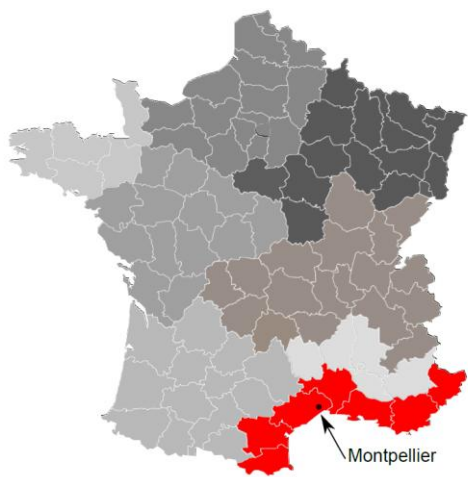

Figure 1



(a)



(b)

Figure 2

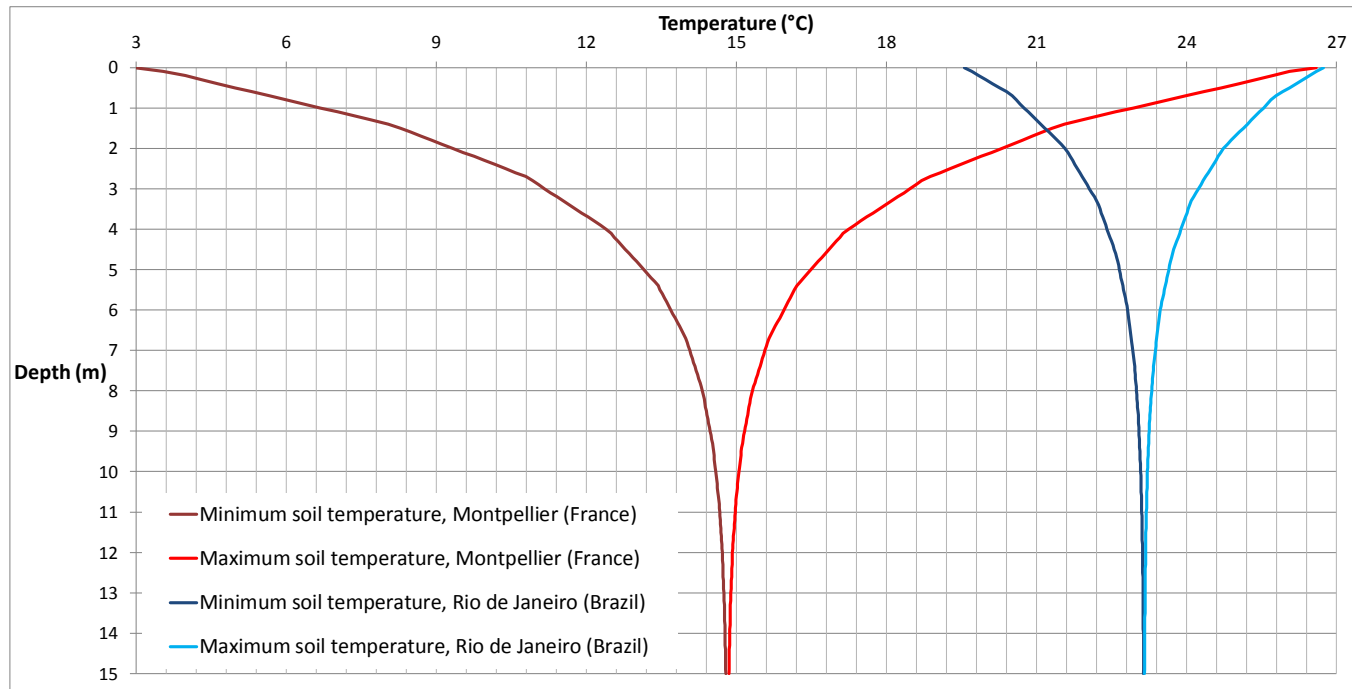

Figure 3

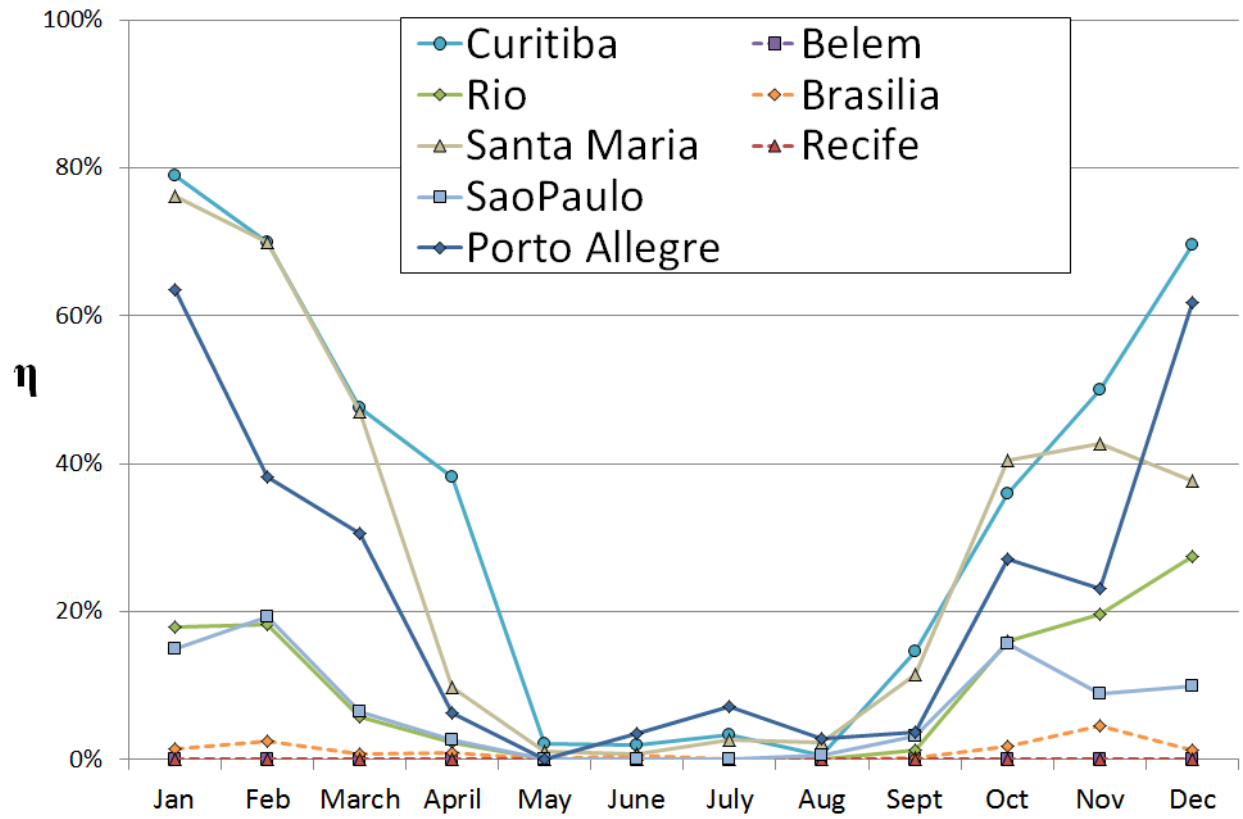

Figure 4

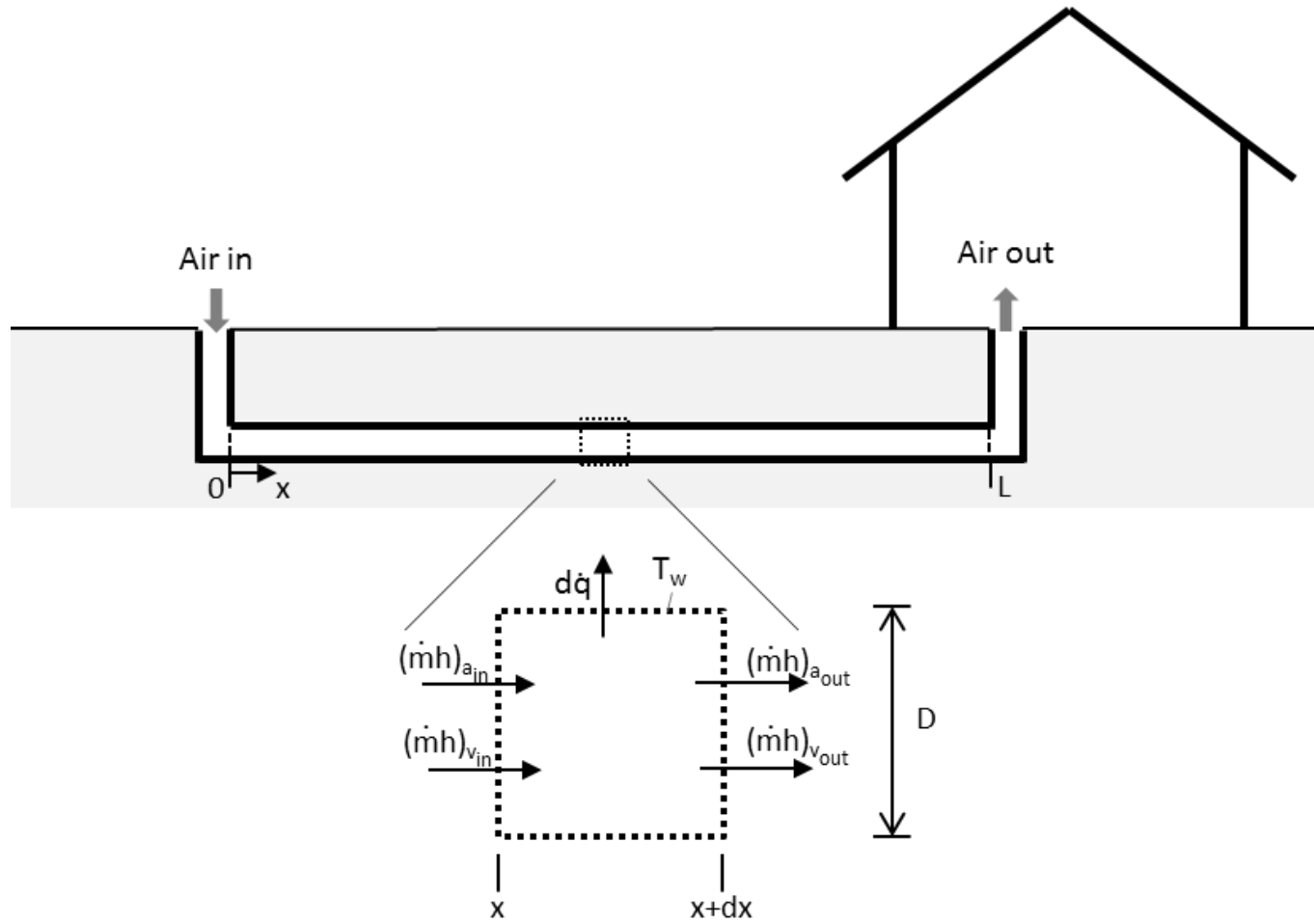

Figure 5

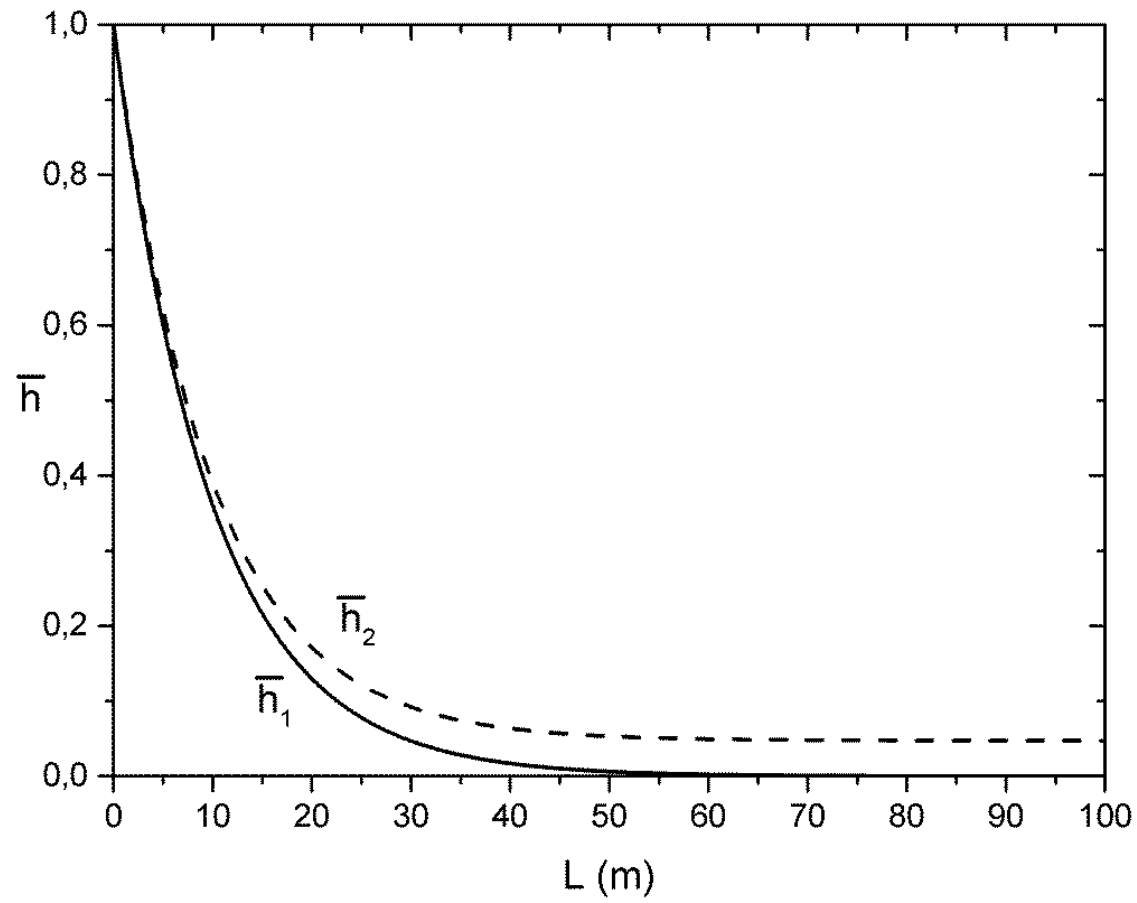

Figure 6

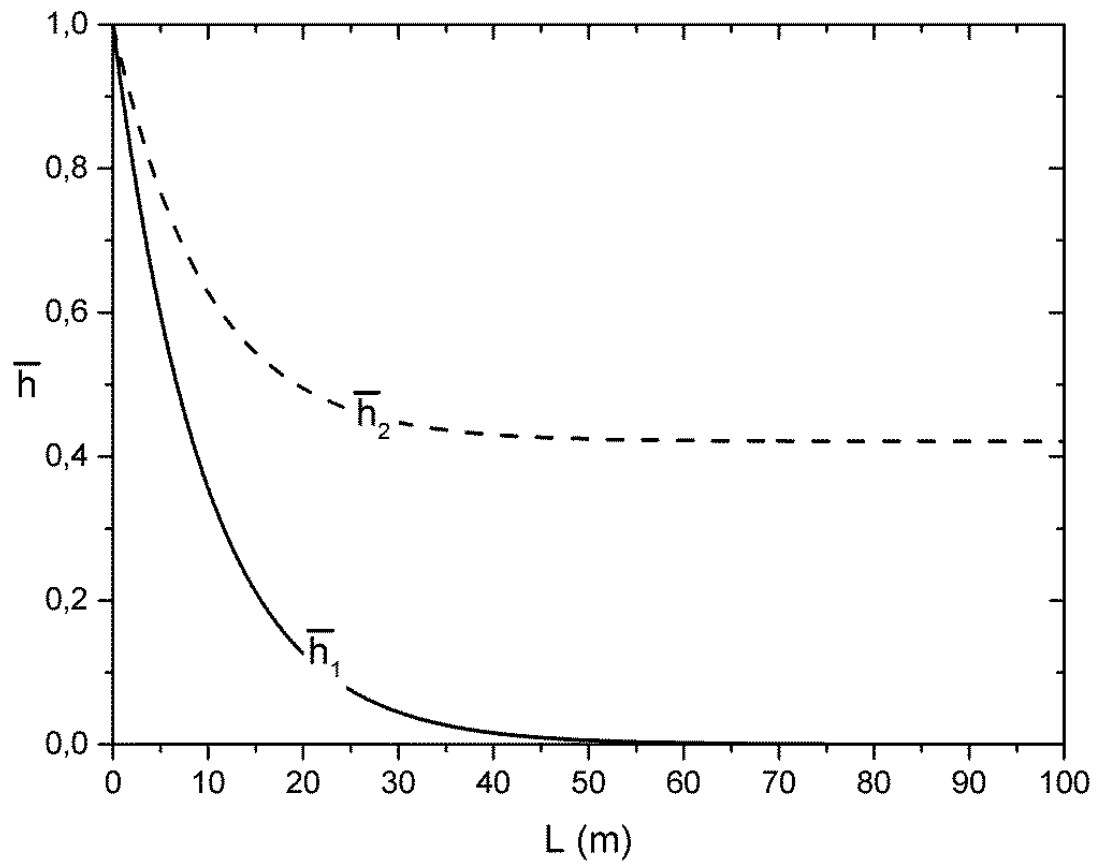

Figure 7

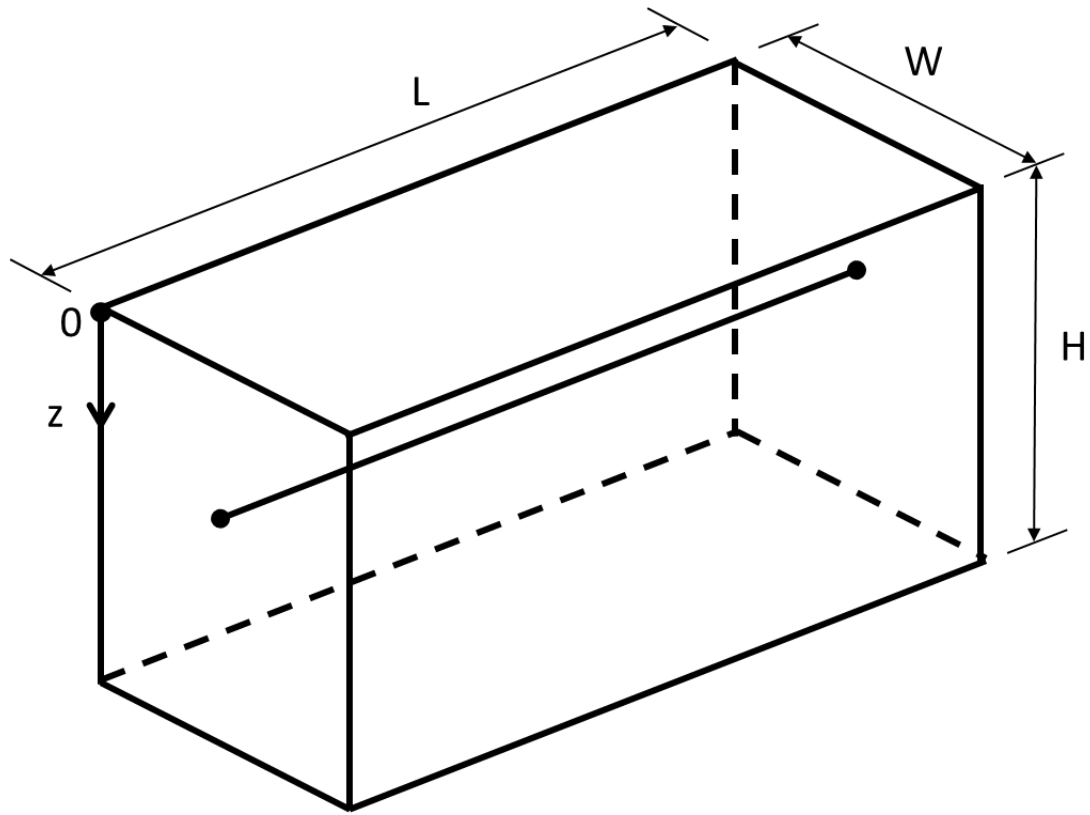

Figure 8



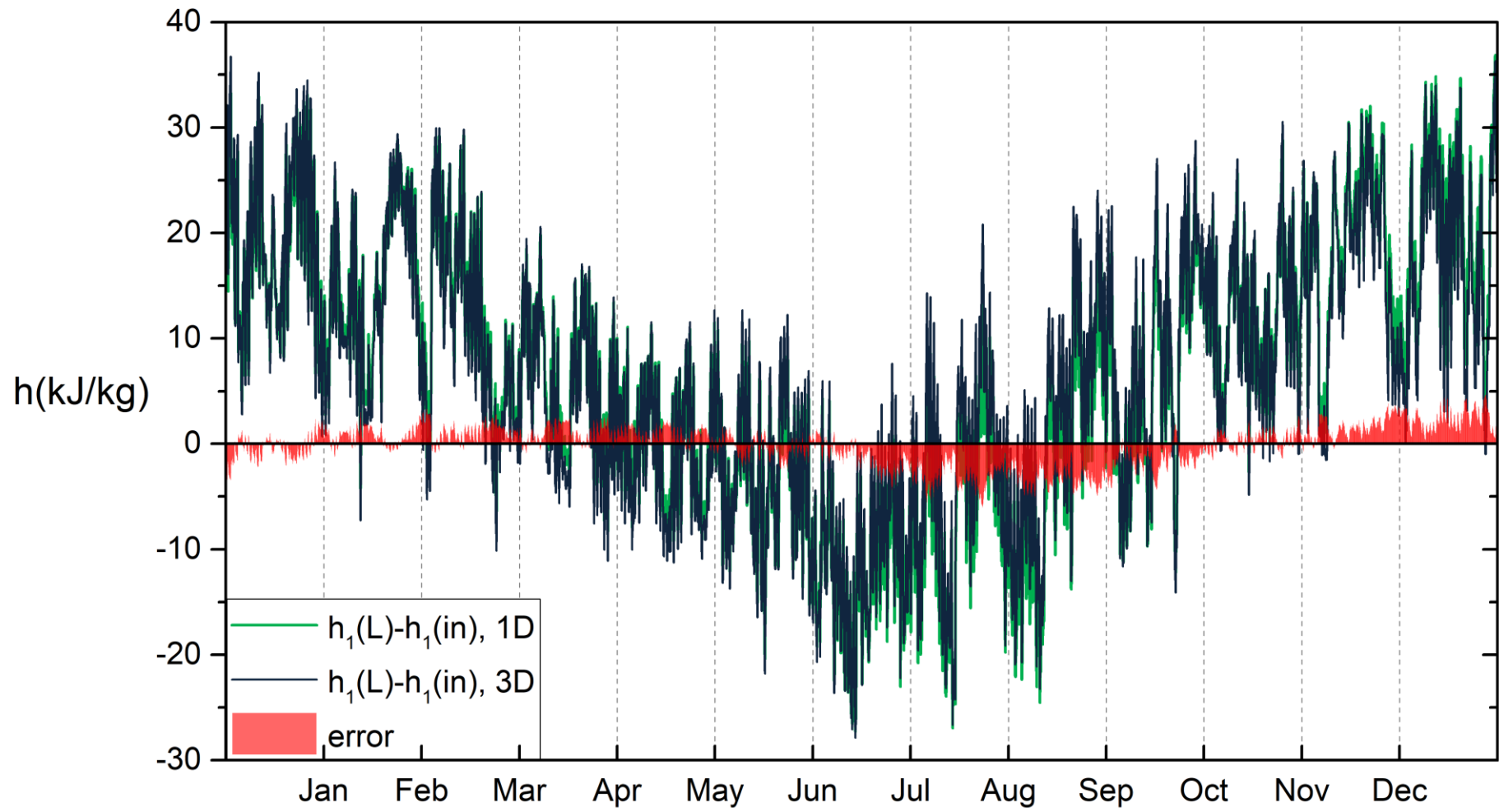

Figure 9

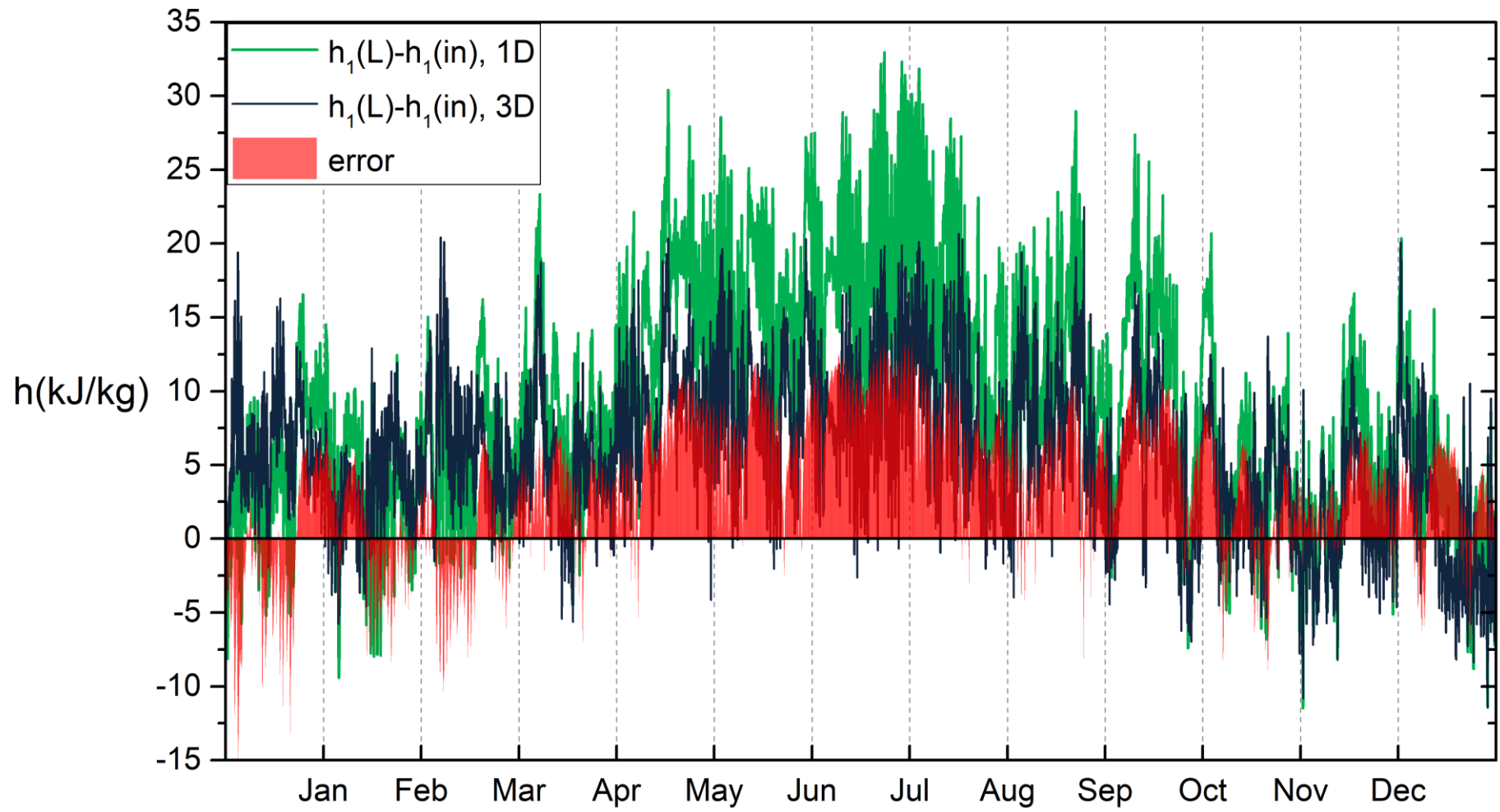

Figure 10

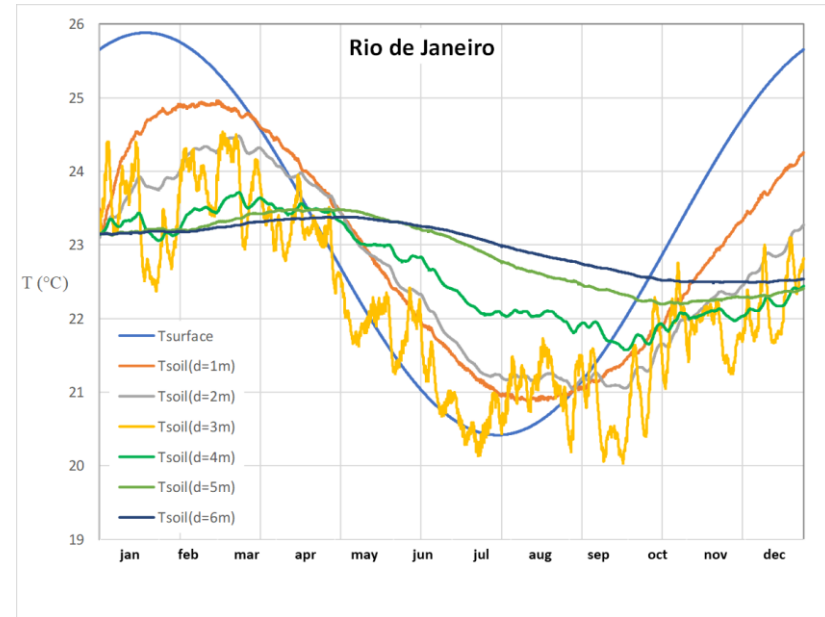
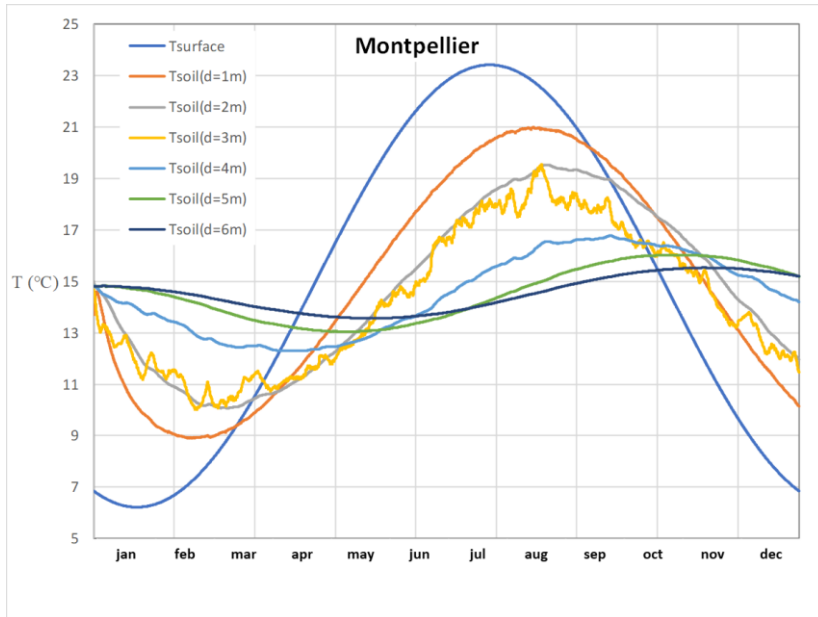

Figure 11

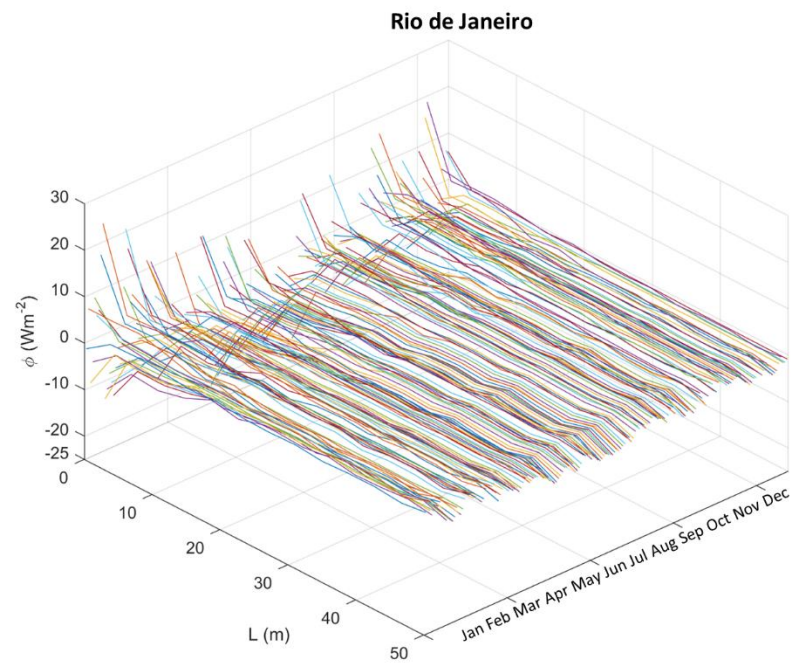
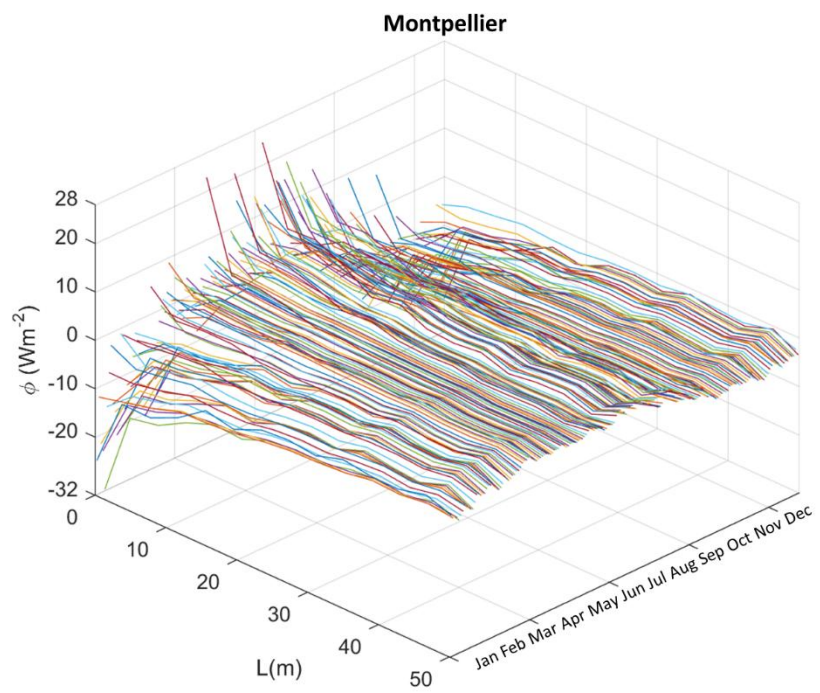

Figure 12

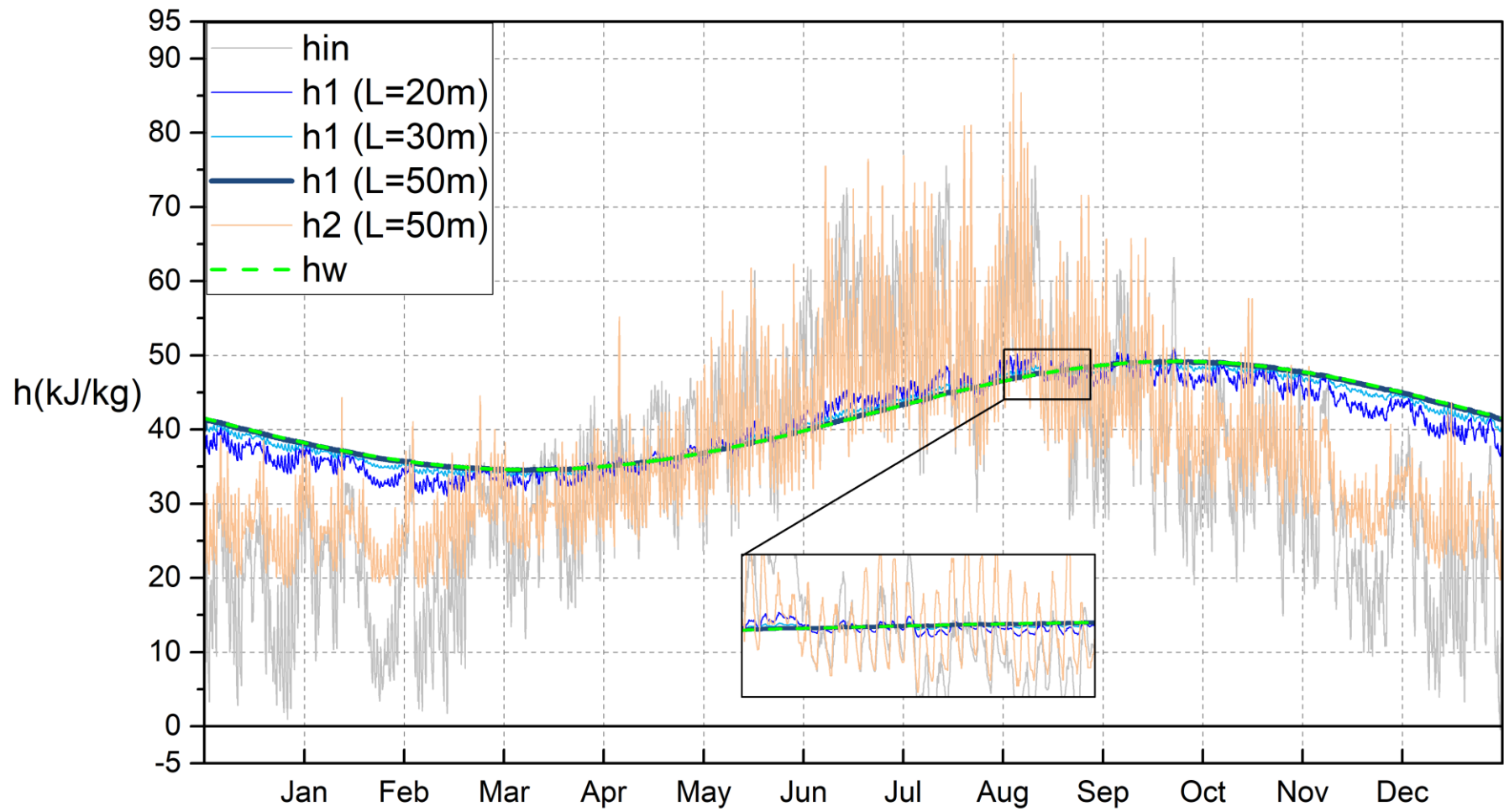

Figure 13

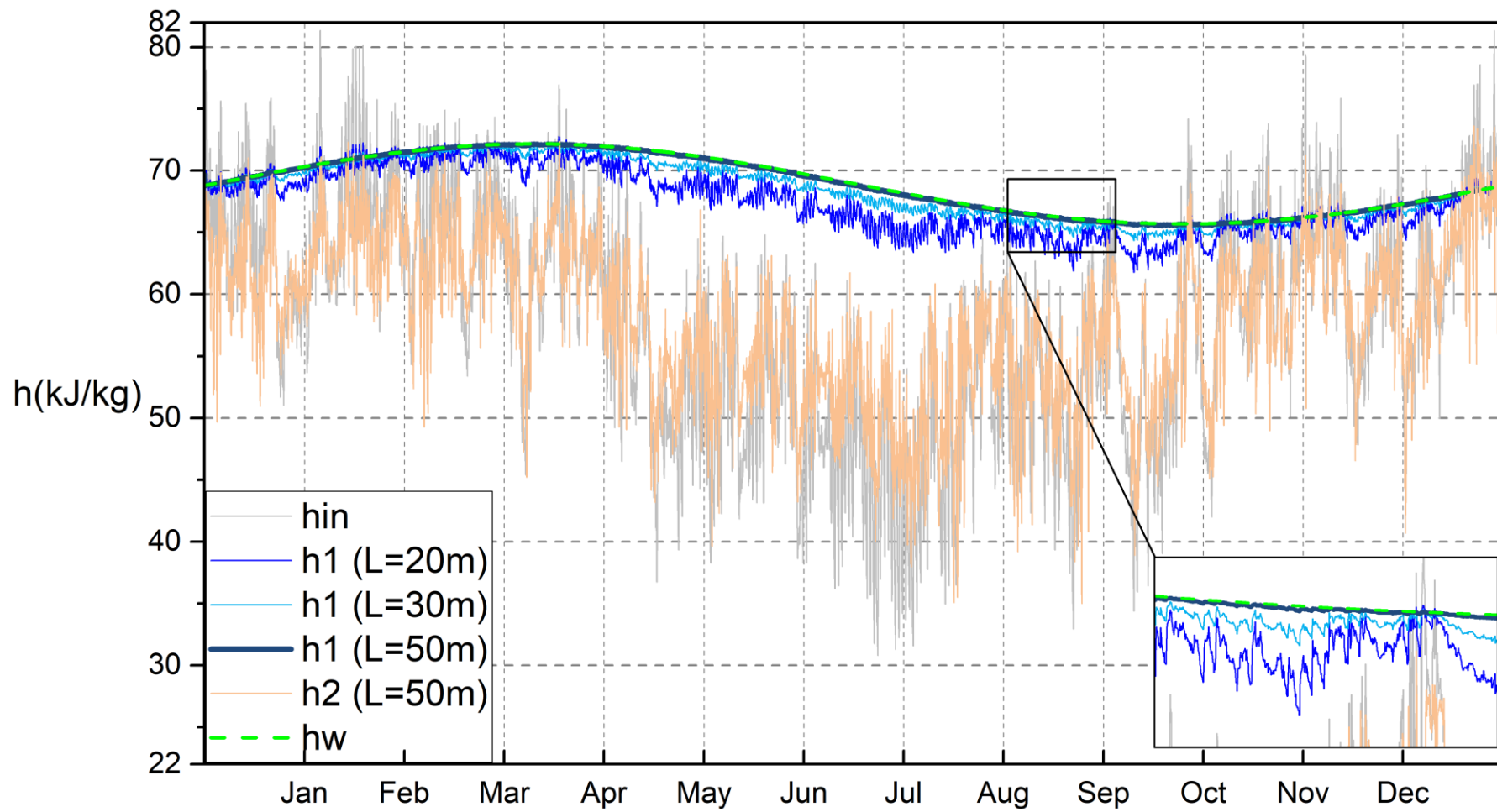

Figure 14

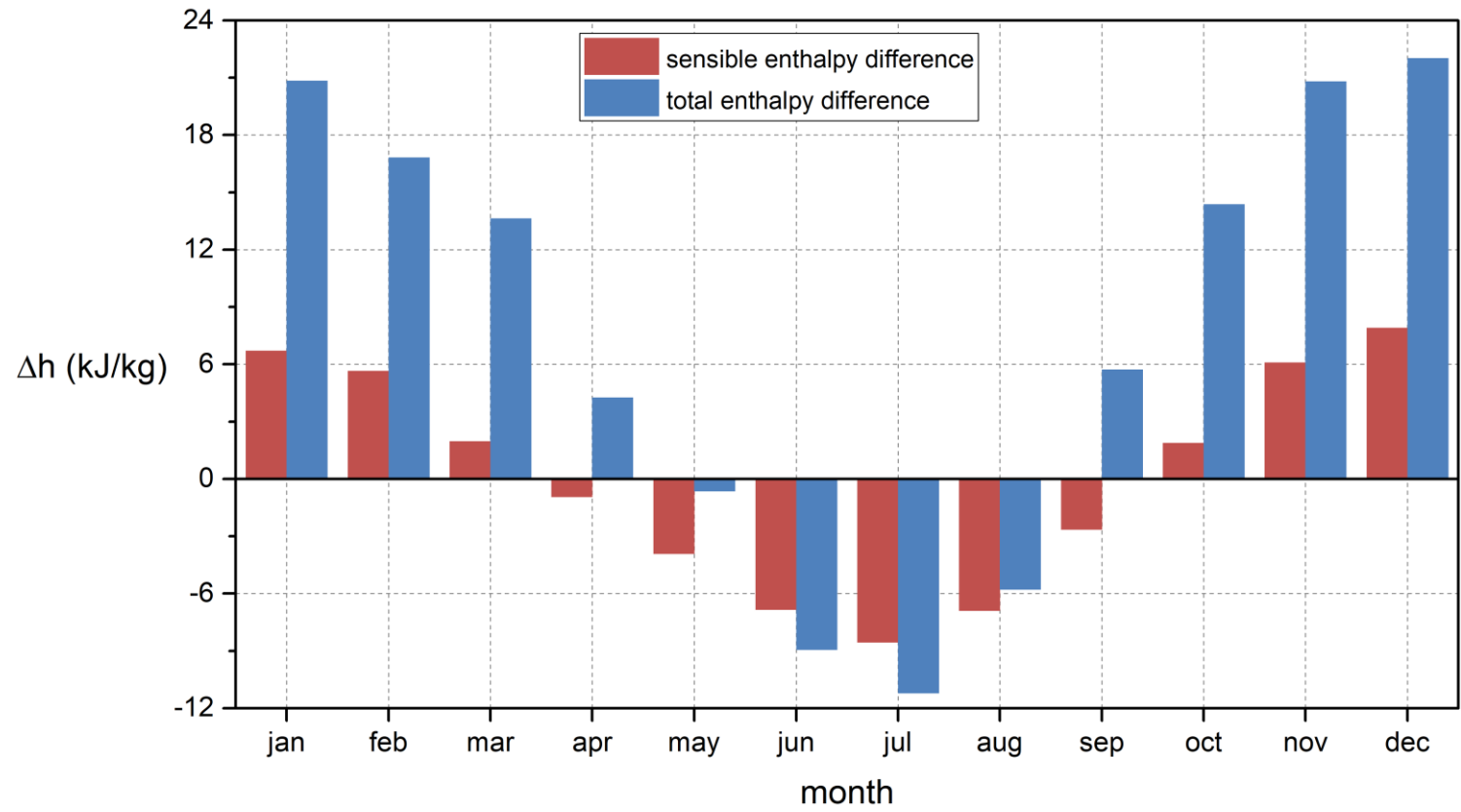

Figure 15

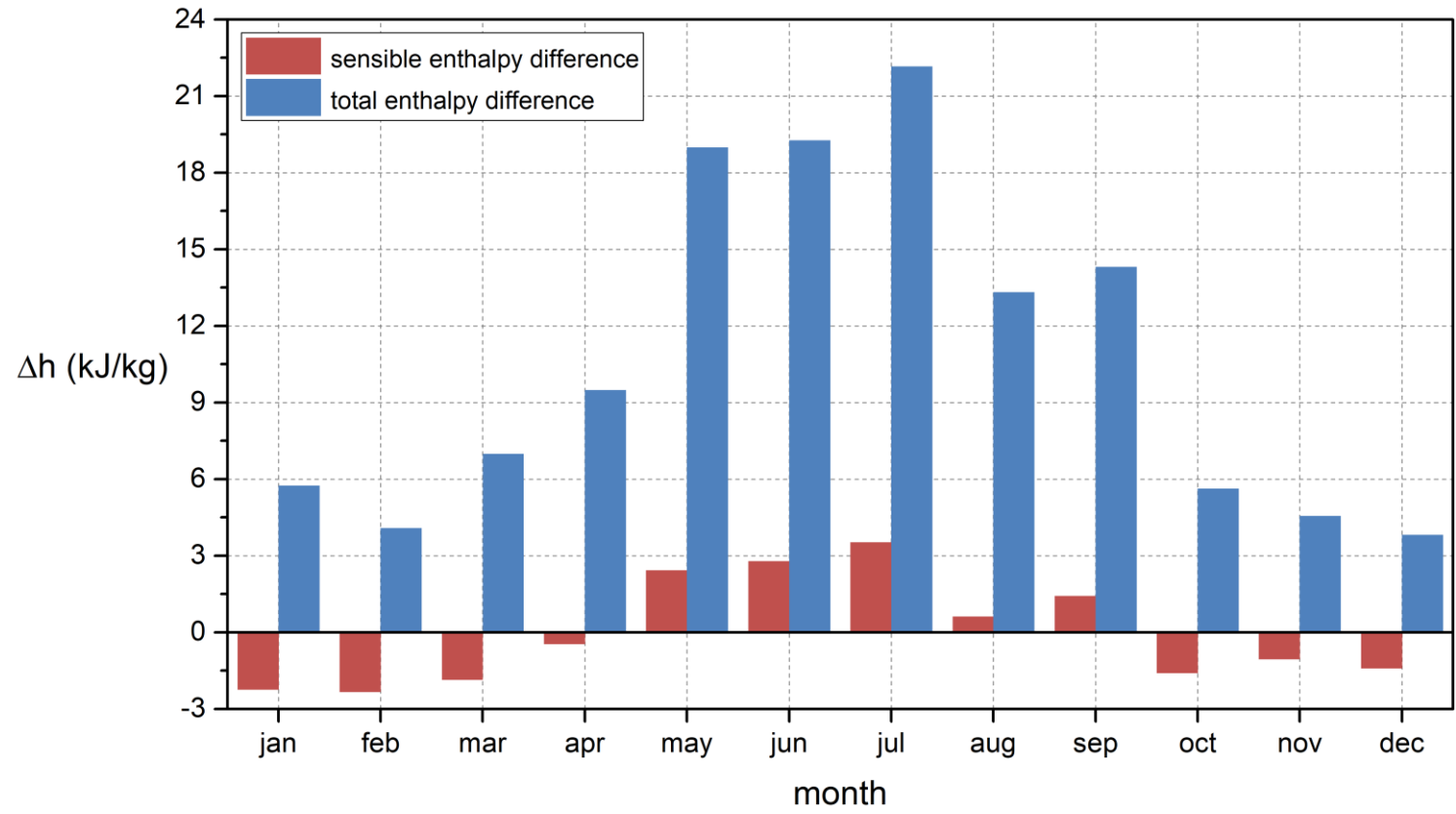

Figure 16



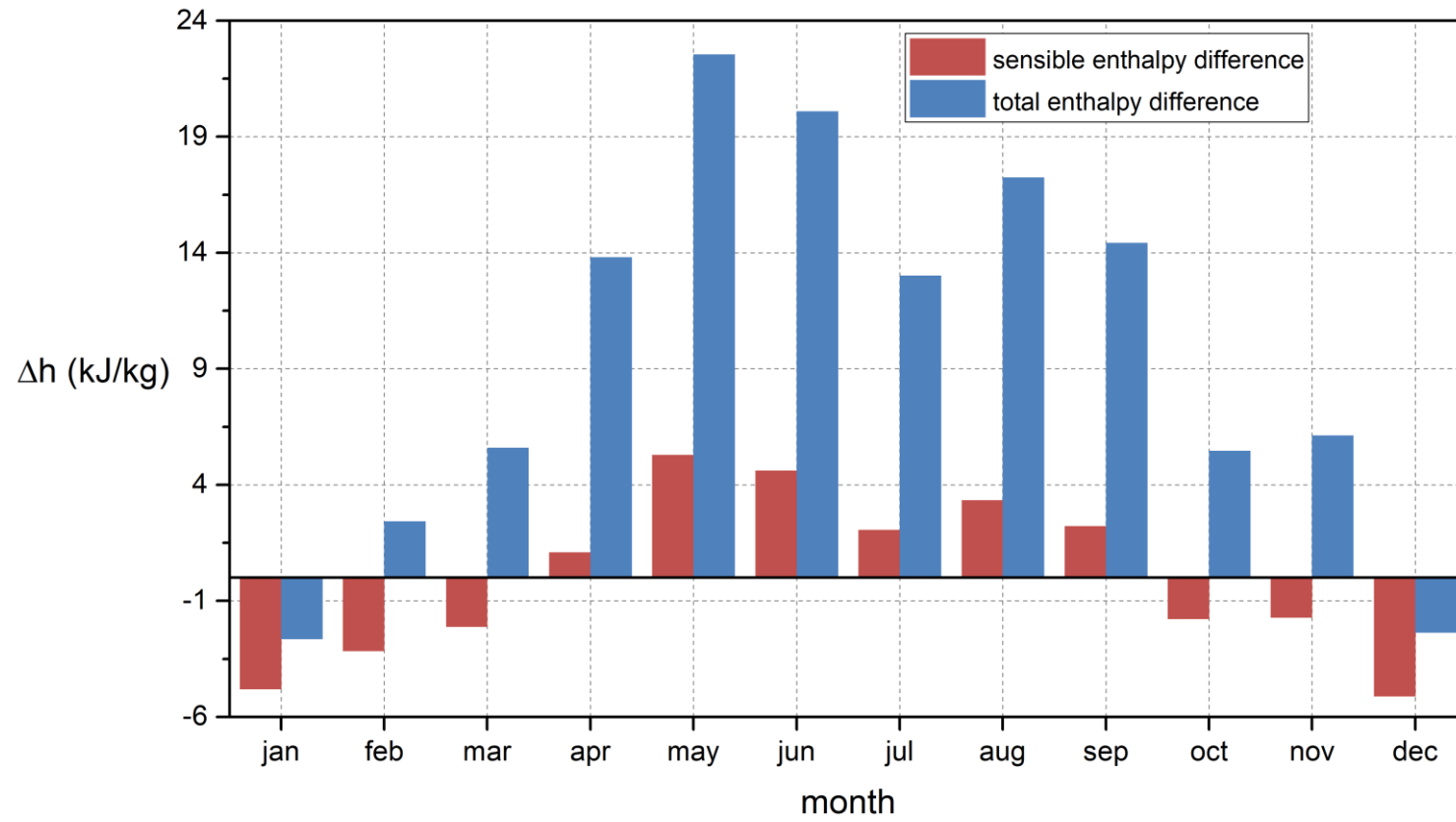

Figure 17