



**HAL**  
open science

# A MORE INTEGRATED DESIGN APPROACH FOR EMBEDDED MECHATRONIC SYSTEMS: APPLICATION TO ELECTRICAL THRUST REVERSER ACTUATION SYSTEMS

Scott Delbecq, Marc Budinger, Jérôme Piaton

► **To cite this version:**

Scott Delbecq, Marc Budinger, Jérôme Piaton. A MORE INTEGRATED DESIGN APPROACH FOR EMBEDDED MECHATRONIC SYSTEMS: APPLICATION TO ELECTRICAL THRUST REVERSER ACTUATION SYSTEMS. ICAS 2018, Congres of the International Council of the Aeronautical Sciences, Sep 2018, Belo Horizonte, Brazil. hal-02065697

**HAL Id: hal-02065697**

**<https://insa-toulouse.hal.science/hal-02065697v1>**

Submitted on 12 Mar 2019

**HAL** is a multi-disciplinary open access archive for the deposit and dissemination of scientific research documents, whether they are published or not. The documents may come from teaching and research institutions in France or abroad, or from public or private research centers.

L'archive ouverte pluridisciplinaire **HAL**, est destinée au dépôt et à la diffusion de documents scientifiques de niveau recherche, publiés ou non, émanant des établissements d'enseignement et de recherche français ou étrangers, des laboratoires publics ou privés.

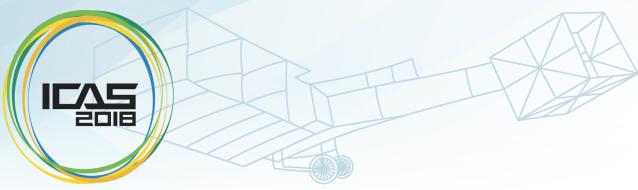

# A MORE INTEGRATED DESIGN APPROACH FOR EMBEDDED MECHATRONIC SYSTEMS: APPLICATION TO ELECTRICAL THRUST REVERSER ACTUATION SYSTEMS

Scott Delbecq<sup>1,2</sup>, Marc Budinger<sup>2</sup>, Jérôme Piaton<sup>1</sup>

<sup>1</sup>Safran Electronics & Defense, <sup>2</sup>ICA, Université de Toulouse, CNRS

**Keywords:** Sizing, Multidisciplinary System Design Optimization, Design Space Exploration, Electromechanical Actuator, Thrust Reverser

## Abstract

*The design of embedded mechatronic systems like electromechanical actuation systems involves heterogeneous knowledge due to the interference of several engineering specializations and the multiple physical laws that govern their behaviour. This results in costly iterations during the design process and non-optimal solutions. Multidisciplinary System Design Optimization techniques provide theoretical foundations and computational tools for optimizing large and multidisciplinary systems. The approach taken uses these techniques within a proposed design and sizing methodology. It allows a holistic sizing of mechatronic engineering systems with emphasis placed on reusability and rapid decision making. This methodology has been applied in an industrial context to size an electrical thrust reverser actuation system. This more integrated design approach has resulted in significant assessments and insights in early trade-off studies for this complex aircraft subsystem.*

## 1 Introduction

Environmental protection is a key driver for next generation aircrafts as drastic goals of Flightpath 2050 are asked by ACARE european council [1]. In order to reduce drastically fuel burn, emissions and noise, new aircraft concepts have been proposed. They investigate innovative propulsion systems [2], propulsion-airframe integration

for boundary layer ingestion [3], structural alloys, systems and equipment architectures. One research axis consists in electrifying propulsion, systems and equipment by betting on the advantages of electrical technologies in terms of integration, maintenance and power efficiency. More than ever, this more electrical aircraft course of action is driving the research and technology of the aeronautical industry and academics. The research axes that concerns non-propulsive systems can be separated in two main axes. The first axis investigates the concept of bleedless aircrafts which consists in replacing pneumatic systems by electrical systems. The second axis investigates the concept of hydraulicless aircrafts which consists in replacing hydraulic systems by electrical systems. These electrical systems are more eco-friendly than hydraulic systems due to the removal of irritating Skydrol fluid, more efficient and are also easier to integrate and maintain. The hydraulicless aircraft concept has lead to the electrification of actuation systems for flight controls [4], landing gears [5] and thrust reversers.

The integration of these new technologies increases risks of unexpected and critical behaviours of systems leading to costly re-designs. These new electrical systems have to prove that they meet the severe reliability and availability requirements of commercial aircraft when operating in a harsh vibratory and thermal environment. Therefore, one of the challenges for developing a more electrical aircraft is to master the

design and integration of the forthcoming mechatronic systems like actuation systems. Hence, emphasis must be placed on developing new design approaches and methodologies to design and size these new technologies that would ensure an optimized and successful integration during future aircraft developments. In parallel, Multidisciplinary Design Optimization (MDO) tools have significantly increased in sophistication in the recent decades. Thus, they have led to many applications such as aircraft conceptual design (0D analytic models), aircraft trajectory optimization (0D-1D lumped parameter models) or high fidelity wing design (3D Finite Element Method models).

This paper will focus on a developed designs and sizing methodology and its application to electrical thrust reverser actuation systems (ETRAS). For that, the paper is organized as follows. Section 2 presents the methodology and its associated framework. Section 3 outlines the architecture, design drivers and sizing scenarios of the ETRAS. Section 4 describes the modelling tasks achieved for this case study. Section 5 presents the design optimization/exploration formulation and the results obtained. Conclusions and future work are presented in Section 6.

## 2 Sizing methodology and associated framework

The design of mechatronic systems involves several stakeholders which have different type of engineering specialization knowledge. The knowledge is available in different engineering teams of the design office as shown in Fig. 1.

During system design the design drivers of the system are well known by the system architect which enables him to manage the other engineering specializations (electronics, electrical machine design, mechanical design, software...) design tasks. The other engineering specialization experts are well aware of technological limits of their components and therefore assess rapidly their performances.

Experienced system architects are able to make system design trade-offs without inter-

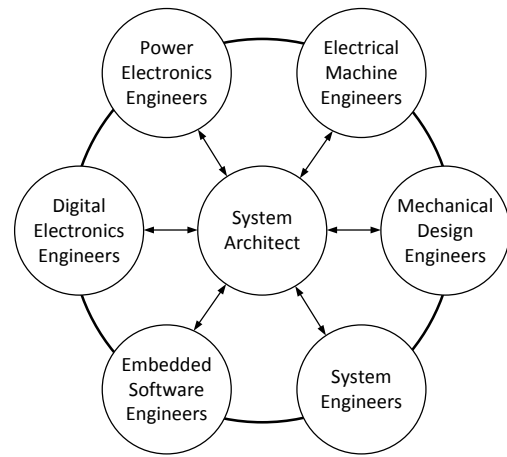

**Fig. 1** Different engineering teams and knowledge flows

acting with other engineering specialization experts. However, for unconventional systems or in the absence of a multi-domain experienced system architects it is not possible. The proposed methodology permits better consideration for engineering specialization knowledge during system sizing. A methodology consists in a process, methods and a framework. This section is organized as so.

### 2.1 Process

A process can be defined as successive steps. The first step consists in the definition of requirements, design drivers and sizing scenarios of the system. Once sizing scenarios are defined, modelling needs are identified and modelling activities can be outlined. The second step is thus the implementation of the models requested for sizing. The third step assembles elementary models into reusable groups that are manageable by a single individual. These groups correspond to component level sizing models. The fourth step assembles these component sizing models to form a complete system sizing model. In the fifth step, the system sizing model is analyzed and optimized. The final and sixth step explores the design space using the system sizing model. The next part summarizes these steps and outlines the associated methods.

## 2.2 Methods

### 2.2.1 Step 1: Requirements, design drivers and sizing scenarios definition

The definition of requirements, design drivers and sizing scenarios has to be achieved through exchange of information between stakeholders during early development phase. The information consists in design knowledge represent needs and constraints of each of the stakeholders. These needs and constraints are translated into requirements and design drivers used to design and size the system. An efficient method to represent each of this knowledge and their interaction is through a system breakdown structure. Nodes represent components, their design drivers and the sizing scenarios. Using different shapes of nodes help distinguish them.

### 2.2.2 Step 2: Elementary computational model generation

In order to provide low computational cost models, the elementary computational model used are algebraic. Algebraic models can be generated using different methods. Analytic models can be obtained by deriving equations representing the laws of physics. Scaling laws are algebraic equations based on reference component [6]. Linear regression of component data sheets provide the possibility to obtain algebraic model that compute component geometrical parameters (length, mass) with respect to performances (torque, speed). Surrogate modelling can be used to fit empirical data or simulation data. Surrogate modelling techniques that generate algebraic models using Finite Element Method (FEM) simulations are available [7]. Surrogate modelling can also be used for representing lumped parameter simulations.

### 2.2.3 Step 3: Elementary models assembly into reusable component sizing models

The assembly of elementary algebraic models enables to use acausal modelling for increasing reusability of models. The combination of graph-based methods and symbolic computation meth-

ods provides techniques to implement an acausal environment. Such methods also permit to detect computation singularities. This step enables to generate flexible inputs/outputs component sizing models composed of elementary algebraic models whilst checking their solvability.

### 2.2.4 Step 4: Component sizing models assembly into a system sizing model

The assembly of component sizing models to form a total system sizing model is intricate because of interconnections between variables that come from the system layer. The method used to represent the system model is the N2 diagram [8]. It is a diagram that represents in the shape of a matrix the functional or physical interfaces between system elements. In addition, a hierarchical decomposition method is used to deal with the complexity of system containing a large number of elements.

### 2.2.5 Step 5: Analysis and optimization using the system sizing model

Analysis and optimization using the system sizing model can be achieved using Multidisciplinary System Design Optimization techniques. Gradient-based methods are used with symbolic differentiation for elementary models derivatives and Unified Derivatives Equations [9] for total derivatives. This leads to low analysis and optimization times which is very interesting for rapid decision making during the sizing process.

### 2.2.6 Step 6: Design space exploration using the system sizing model

Design space exploration using the system sizing model can be achieved using Multidisciplinary System Design Optimization techniques for multidisciplinary analysis and Design of Experiments. Visualization methods like parallel coordinates and scatter plots provide efficient features for design and sizing purposes.

### 2.3 Framework

Step 3 to 6 are supported by a in-house framework called BOA (Bind your models, Optimize your system, Accelerate your design) [10]. To match the process this framework is decomposed in four environments: Block Generation, Sizing Procedure, Design and Exploration. It was developed using Python programming language. The computational core relies on key scientific computing packages like Scipy, Numpy, Sympy, NetworkX, pyDOE and OpenMDAO [11]. The user interface was implemented using PyQt5. Fig. 2 illustrates the user interface of the sizing procedure environment.

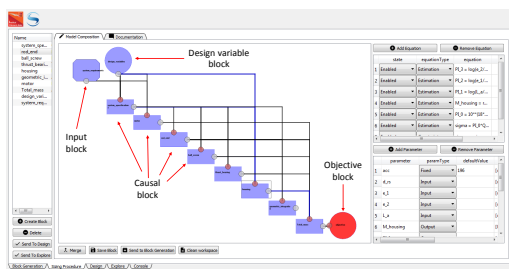

Fig. 2 Sizing Procedure environment

This framework has been used to achieve the sizing of aileron rotary [12] and linear [13] electromechanical actuators and more recently a primary flight control actuation system [14]. For the first time, it is used to achieve a conceptual sizing of an ETRAS. This example is described in the following sections. The problem is non-exhaustive but includes the main challenges of ETRAS design and sizing.

## 3 Architecture, design drivers and sizing scenarios

The ETRAS is supplied by the AC voltage network of the aircraft. It has to deploy and stow the engine nacelle transcowl(s) during landing. The transcowl is part of the thrust reverser system and can have either two symmetrical transcowls (C-duct) or one same transcowl (O-duct). A O-duct transcowl is considered in this case study.

### 3.1 Architecture

The ETRAS includes an electrical power chain and an electromechanical power chain. The electrical power chain main components are an Auto-transformer Rectifier Unit (ATRU), an inverter, a braking resistor and a housing. The electromechanical power chain main components are a brushless motor, flexshafts and linear actuators. This architecture is illustrated in Fig. 3.

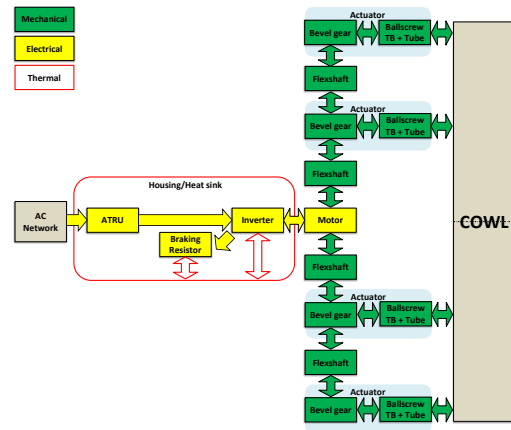

Fig. 3 ETRAS power architecture

The ATRU includes an autotransformer, two rectifiers and two interphase inductors. An actuator includes a bevel gear, a thrust bearing, a ball screw and its tube (housing). We focus here on the sizing of components that have a significant effect on the total mass of the system. Hence, the sizing of the system includes the autotransformer, the braking resistor, the housing which acts as a heat sink for the braking resistor and inverter, the motor, flexshafts and actuators.

### 3.2 Design drivers

The system design drivers considered for this study are the requirements such as fail-safe system, aerodynamic loads and the transcowl mass. The Aborted Take Off (ATO) deploy and stow performances are specified as a maximum time to achieve full stroke. Hence, position/speed mission profile for both sequences are considered as a system design driver.

Design drivers are given for each component. The main design driver of the autotransformer,

the braking resistor and the housing is their maximum operating temperature. Since the ETRAS application is very short (typically a few seconds), only heat capacities of components are used to estimate their maximum temperature. The braking resistor is also selected on its peak power. The braking resistor resistance has also to be carefully adapted to DC bus voltage. The main design drivers of brushless motors for dynamic and transient applications are maximum torque, maximum speed, maximum temperature and inertia. For flexshafts their maximum/fatigue torque and maximum speed are technological limits whereas rotational stiffness and inertia parasitic characteristics. Bevel gears are selected on their reduction ratio and maximum/fatigue torque whereas inertia is a parasitic characteristic that has an effect on the sizing problem. Thrust bearings are selected using the maximum/fatigue axial force. The main design drivers of ball screws are their pitch, the maximum/fatigue axial force and axial stiffness.

### **3.3 Sizing scenarios**

The first sizing scenario considered is the ATO deploy at cold temperatures (high friction in actuators and flexshafts). The torque and speed mission profile depends on the deploy position/speed profile, inertias, transcowl mass, aerodynamic loads and mechanical efficiency. It has a significant effect on motor maximum torque and speed and the autotransformer peak power. The aerodynamic load are position dependent. The deploy sequence begins with a phase where the motor drives the transcowl and follows with a phase where the motor brakes the transcowl and thus generates energy.

The second sizing scenario considered is the ATO deploy at hot temperatures (low friction in actuators and flexshafts). The high mechanical efficiency leads to more braking torque for the motor, higher peak power and more energy to dissipate for the braking resistor.

The third sizing scenario taken into account is the stow at cold temperatures. Loads are smaller than the ATO deploy but there is no braking phase

so the motor is always driving the transcowl. Hence, it does not determine peak torque or power for motor and autotransformer but generate important energy losses that they have to contain thanks to their intrinsic heat capacity.

The fourth and fifth sizing scenarios taken into account are jamming failure modes. As the system has to be fail-safe, all components shall resist to such event. The loads taken are for ATO deploy. The stress generated in mechanical components depends on inertias, stiffness, transcowl mass and motor torque/speed operating point at jamming.

Fig. 4 outlines the architecture considered for the sizing problem, the different design drivers and sizing scenarios as well as their interactions and therefore the high complexity of the ETRAS design.

## **4 Sizing models**

The sizing models used enable to compute the quantity of interest of sizing scenarios. Estimation models are also used to determine component parameters involved in sizing scenarios models. Efforts are made to use algebraic models for optimization by introducing 0D models (scaling laws, analytic), surrogate models of 0D-1D (Dymola) and 3D models (FEM).

### **4.1 Sizing scenarios models**

A surrogate model of lumped parameter model simulation is used to represent ATO deploy (cold and hot) and stow (cold). A 0D-1D lumped parameter model is achieved using Dymola Software. It computes the maximum power, torque, speed and energy at transcowl level during motor and generator (Deploy only) phases with respect to aerodynamic loads, total inertia of the system and a one degree of freedom trapezoidal speed profile. The trapezoidal speed profile is implemented so that the only degree of freedom is maximum speed at transcowl level. The model uses the inverse simulation features of Dymola as shown in Fig. 5.

A Latin Hypercube Sampling of 1000 sam-

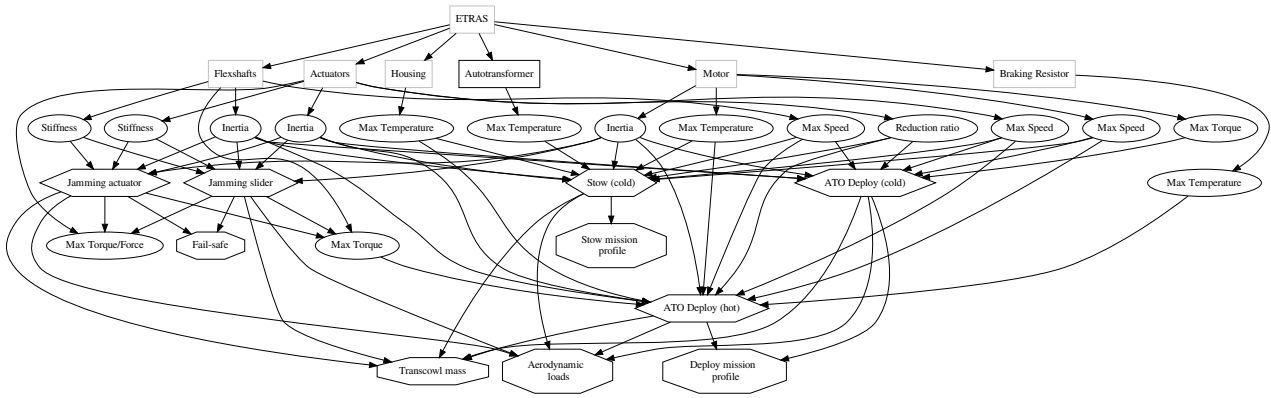

**Fig. 4** Non-exhaustive system breakdown graph of the ETRAS sizing problem with component design drivers (oval), system design drivers (octogone) and sizing scenarios (hexagone)

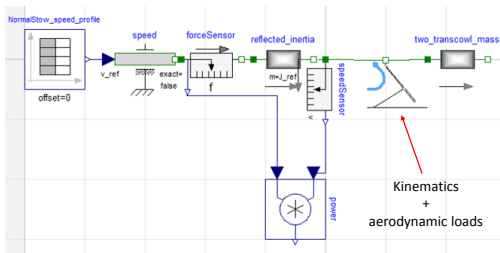

**Fig. 5** Stow mission profile model at transcowl level in Dymola

ples is achieved on total system reflected inertia and speed profile parameter. The simulations are executed using a co-simulation Functional Mock-up Unit. Post-analysis computes the quantity of interest (energy, peak power...) for each simulation and then a third-order polynomial response surface surrogate is used to represent them with respect to total system inertia and speed profile parameter.

As the ETRAS operates during a very short time, components maximum temperature sizing scenario are computed with respect to the equivalent energy of losses and heat capacity.

Maximum speed of motor and flexshafts are checked using analytic models.

Jamming sizing scenarios models compute the peak torque/force applied on mechanical components with respect to inertias, stiffness, aerodynamic loads, motor torque and speed.

They use an analytic model (Equation 1) that assumes that the equivalent kinetic energy of spinning inertias is transformed into potential elastic energy of mechanical stiffness.

$$F_{jam} = \sqrt{M_{eq}K_{eq}V^2} \quad (1)$$

Where  $F_{jam}$  is the jamming force,  $V$  the equivalent mass's ( $M_{eq}$ ) speed and  $K_{eq}$  the equivalent stiffness at the jamming point.

## 4.2 Estimation models

The autotransformer sizing is achieved using scaling laws and an existing design. The autotransformer is sized for constant magnetic saturation as it operates during a very short time. However, the thermal behaviour has to be checked. Hence, the heat capacity is also estimated using a scaling law.

The braking resistor electrical resistance and thermal resistance are obtained using manufacturer analytic model. The housing heat capacity, which acts as a heat sink for the braking resistor and the inverter, is obtained with an analytic model.

The motor electromagnetic model is obtained using surrogate modelling of FEM simulations (Fig. 5). It considers the magnetic saturation of the core material. It computes the electromagnetic torque with respect to three high level variables, the stator diameter, the yoke thickness

and current density in the windings. Models that compute Joules and iron losses are also implemented. Details of this model can be found in [7].

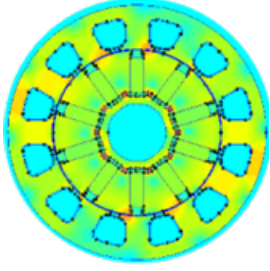

**Fig. 6** Brushless motor electromagnetic FEM model using FEMM

Flexshafts diameter, stiffness (Equation 2), inertia and mass are estimated using scaling laws with respect to peak torque.

$$K_{fs} = G_{l_{ref}}^{-1} \left( \frac{T_{fs}}{T_{fs_{ref}}} \right)^{\frac{4}{3}} L_{fs}^{-1} \quad (2)$$

Where  $K_{fs}$  is the flexshaft stiffness,  $G_{l_{ref}}$  and  $T_{fs_{ref}}$  respectively the linear torsional deflection and peak torque of a reference flexshaft,  $T_{fs}$  the flexshaft peak torque and  $L_{fs}$  the length of the flexshaft.

The bevel gear is sized using a scaling law that assumes the tooth contact stress to be the main effect on gear mass.

Ball screw parameters are estimated using scaling laws with respect to peak axial load. However, buckling load is checked using a scaling law as well.

Thrust bearing scaling law assumes Hertz contact stress as the main design driver.

### 4.3 System sizing model

The system sizing model assembles all the sizing scenarios and parameter estimation models. The mission profile analysis evaluates the ATO deploy (cold and hot) and Stow (cold) with respect to their respective speed profile parameter and total system inertia. It analyzes the more constraining variables in the different operating quadrants for the components sizing such as maximum speed, maximum load and energy. These

sizing inputs are then distributed to the different component sizing bricks. The system level design variables are two speed profile parameters, spur gears reduction ratio, motor stator diameter, yoke thickness and current density. The system level outputs of the sizing model are autotransformer, braking resistor, housing and motor temperatures. Motor and flexshaft maximum speeds have also to be evaluated.

The sizing problem includes two multidisciplinary couplings. First, the total system inertia is required to compute mission profile analysis but is evaluated using the inertia of components estimated with respect to the outputs of mission profile analysis. The second multidisciplinary coupling comes from the jamming scenarios. The inertias and stiffness of components are required to achieve jamming load analysis but are evaluated using components sizing models that require the value of this jamming load. Hence, these multidisciplinary couplings have to be solved to provide a consistent design solution.

A Multidisciplinary System Design Optimization monolithic formulation is used to solve them. It consists in adding a normalized design variable and an inequality constraint for each coupling and the system total mass as an objective. For example, the first coupling can be described by:

$$\begin{aligned} F_{nom} &= f(J_s, \alpha) \\ J_s &= g(F_{nom}) \end{aligned} \quad (3)$$

Where  $F_{nom}$  is the nominal force from the mission profile analysis,  $\alpha$  the ATO deploy speed profile parameter and  $J_s$  the system total inertia.

Is transformed into:

$$\begin{aligned} F_{nom} &= k_{os} \cdot h(\alpha) \\ J_s &= g(F_{nom}) \\ F_{nom} &\geq f(J_s, \alpha) \end{aligned} \quad (4)$$

Where  $h = f(J_s = 0, \alpha)$ .

This formulation has a lighter computational cost compared to other monolithic formulations like Individual Discipline Feasible (IDF) or All At Once (AAO) [15]. Nevertheless, the use of the inequality is only possible because decreasing



the nominal force  $F_{nom}$  decreases the total system mass and that is the objective.

## 5 Design optimization and exploration

### 5.1 Formulation

The representation of the system sizing model and optimization problem is given in Fig. 7 using the Extended Design Structure Matrix diagram [16].

The sizing optimization implemented minimizes the total mass of the ETRAS  $M_{tot}$  with respect to deploy and stow speed profile parameter  $\alpha_d, \alpha_s$ , motor diameter  $D_{mot}$ , yoke thickness  $e_y$ , current density  $J_{cur}$  and consistency variables for mission profile load analysis  $k_{osF}$  and jamming scenario  $k_{osjam}$ . The constraints come from technological limits of components like maximum speed  $\Omega_*$  and maximum temperature  $\Theta_*$ . Two consistency constraints introduced previously are used to solve the two multidisciplinary couplings. The optimization problem formulation is the following:

$$\begin{aligned}
 & \text{minimize} && M_{tot} \\
 & \text{with respect to} && \alpha_d, \alpha_s, N_{red}, D_{mot}, \\
 & && e_y, J_{cur}, k_{osF}, k_{osjam} \\
 & \text{subject to} && \Omega_{mot} - \Omega_{mot_{max}} \leq 0 \\
 & && \Omega_{fs} - \Omega_{fs_{max}} \leq 0 \\
 & && F_{dyn} - F_{nom} \leq 0 \\
 & && F_{jam_s} - F_{nom_{mech}} \leq 0 \\
 & && F_{jam_{bs}} - F_{nom_{mech}} \leq 0 \\
 & && \Theta_{at} - \Theta_{at_{max}} \leq 0 \\
 & && \Theta_{hous} - \Theta_{hous_{max}} \leq 0 \\
 & && \Theta_{br} - \Theta_{br_{max}} \leq 0 \\
 & && \Theta_{mot} - \Theta_{mot_{max}} \leq 0
 \end{aligned} \tag{5}$$

Performing this optimization provides the possibility to assess rapidly integration parameters such as mass and dimensions of the system in order to make system integration trade-offs.

For example such sizing code can assess the effect of changes of requirements like deploy time on the total system mass. In addition, the

effect of changes of technologies like motor inertia can be evaluated rapidly.

### 5.2 Results

The study of the effect sizing scenarios on the global design is used to illustrate both the utilization of the methodology and the sizing problem. The sizing scenarios such as jamming and many other have to be included in the design in order to avoid non-compliant design solutions. Fig. 8 outlines optimization results in terms of mass breakdown of the ETRAS when considering and not considering the slider jamming and ball screw jamming.

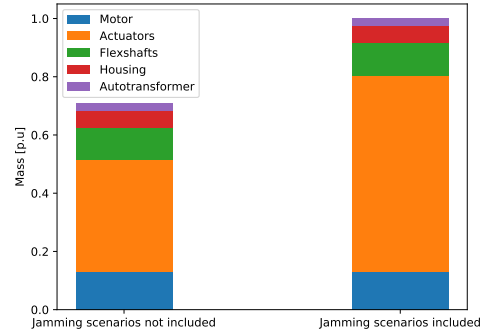

**Fig. 8** Mass breakdown optimization results without (left) and with (right) jamming scenarios

Results show that these jamming scenarios have a significant impact on the mass of the actuators. As they are the main source of mass, it directly impacts the system total mass. Therefore, emphasis must be placed on implementing sizing codes that enable the consideration of a large number of sizing scenarios, design variables and design constraints.

### 5.3 Discussions

The proposed more integrated design approach uses a in-house framework. This framework provides the possibility to capitalize the knowledge through sizing models libraries and sizing projects libraries. This way sizing scenarios can be reused for other projects. This is a tremendous feature as generations of experts have started to

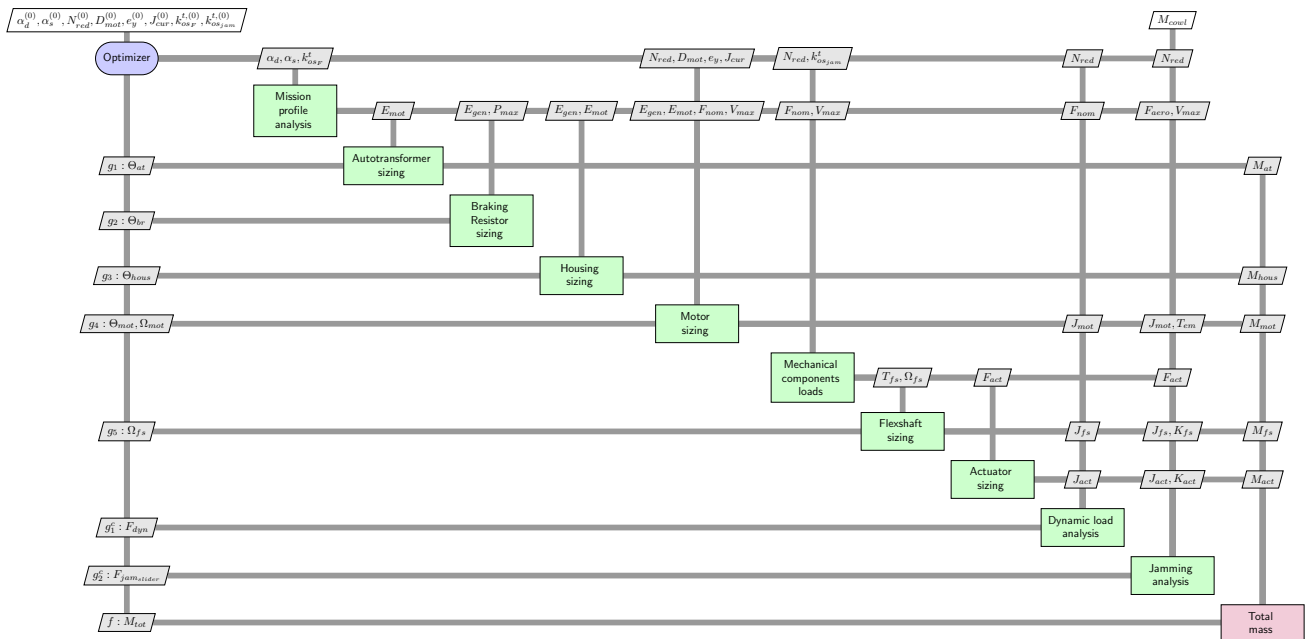

Fig. 7 XDSM diagram for the ETRAS sizing optimization problem

retire and leave organizations with their precious expertise. The sizing scenarios of the ETRAS case study presented in this paper come from the main design drivers of the system. Nevertheless, the sizing of the ETRAS includes also scenarios that have not been taken into account such as geometric integration or different voltage/power supply configurations. However, this confirms that design sizing methodologies are mandatory to design such complex systems in a holistic and tightly coupled manner.

## 6 Conclusion and future work

The more electrical aircraft course of action has lead to the integration of new electrical technologies like electromechanical actuation systems. The introduction of such technologies requires to developed design and sizing methodologies in order to achieve successful developments. Such design and sizing methodology and its associated in-house framework have been outlined. It enables to integrate different engineering specialization knowledge to achieve a holistic sizing of the system. This permits to capitalize expertise knowledge throughout the design process that can be reused easily for forthcoming projects. In

addition, the framework includes rapid optimization and exploration capabilities as emphasis is placed on rapid decision-making during early design phases. Then, this methodology was applied to the sizing of an ETRAS where a large number of disciplines and scenarios, various types of models (0D,1D,3D) and multiple couplings were involved as typical MDO applications.

This paper has shown that it is possible to integrate and capitalize different engineering specialization expertise in one same design and sizing environment. The ETRAS had not yet been treated in scientific literature. This paper is an introduction to the complexity of such system as only the main sizing scenarios were considered. However, this offers interesting perspectives for future work. The mission profile has a significant effect on the total system sizing. Hence, future work will include the optimization of both mission profile and motor control strategies.

## References

- [1] Kallas S, Geoghegan-Quinn M, Darecki M, Edelstenne C, Enders T, Fernandez E and Hartman, P. Flightpath 2050 europe's vision for aviation. *Report of the High Level Group on Avia-*

- tion Research, European Commission, Brussels, Belgium, 2011.
- [2] Charier G and Gallet F. System of compact contra-rotating propellers. *U.S. Patent No. 9,057,326.*, 2015.
- [3] Gray J, Mader C, Kenway G and Martins J. Modeling boundary layer ingestion using a coupled aeropropulsive analysis. *Journal of Aircraft*, Vol. 55, No. 3, pp 1191-1199, 2017.
- [4] Van Den Bossche D . Model Based Design and Experimental Validation of Electro-mechanic Actuator Systems for a Nose Landing Gear. *Proc International Congress of the Aeronautical Sciences*, Hamburg, Germany, 2006.
- [5] Doberstein D and Thielecke F. Model Based Design and Experimental Validation of Electro-mechanic Actuator Systems for a Nose Landing Gear. *Proc International Congress of the Aeronautical Sciences*, Brisbane, Australia, 2012.
- [6] Budinger M, Liscouët J, Hospital F and Maré J-C. Estimation models for the preliminary design of electromechanical actuators. *Institution of Mechanical Engineers, Part G: Journal of Aerospace Engineering*, 226(3), 243-259, 2012.
- [7] Sanchez F, Budinger M and Hazyuk I. Dimensional analysis and surrogate models for the thermal modeling of Multiphysics systems. *Applied Thermal Engineering*, 10, 758-771, 2017.
- [8] Kapurch S J. *NASA systems engineering handbook*. Diane Publishing, 2010.
- [9] Martins J R and Hwang J T. Review and unification of methods for computing derivatives of multidisciplinary computational models. *AIAA journal*, 51(11), 2582-2599, 2013.
- [10] Delbecq S, Budinger M, Hazyuk I, Sanchez F and Piaton J. A framework for sizing embedded mechatronic systems during preliminary design. *Proc IFAC-PapersOnLine*, 50(1):4354 – 4359, Toulouse, France, 2017.
- [11] Gray J, Moore K and Naylor B. OpenM-DAO: An open source framework for multidisciplinary analysis and optimization. *13th AIAA/ISSMO Multidisciplinary Analysis Optimization Conference*, Fort Worth, Texas, USA, 2010.
- [12] Sanchez F and Delbecq S. Surrogate modeling technique for the conceptual and preliminary design of embedded actuation systems and components. *Proc International Congress of the Aeronautical Sciences*, Daejeon, Korea, 2016.
- [13] Delbecq S, Tajan F, Budinger M, Maré J.-C and Sanchez F. A framework for the conceptual and preliminary design of embedded mechatronic systems. *Proc International Workshop on aircraft System Technologies*, Hamburg, Germany, 2017.
- [14] Delbecq S, Budinger M, Piaton J, Daguse B. Optimization of primary flight control actuation system using parametric sizing models of actuators, power electronics and structural analysis. *Recent Advances in Aerospace Actuation Systems and Components*, Toulouse, France, 2018.
- [15] Martins J R and Lambe A. Multidisciplinary Design Optimization: A Survey of Architectures. *AIAA journal*, 51(9), 2049-2075, 2013.
- [16] Lambe A and Martins J R. Extensions to the design structure matrix for the description of multidisciplinary design, analysis, and optimization processes. *Structural and Multidisciplinary Optimization*, 46(2), 273-284, 2012.

### Contact Author Email Address

mailto: scott.delbecq@safrangroup.com

mailto: marc.budinger@insa-toulouse.fr

### Copyright Statement

The authors confirm that they, and/or their company or organization, hold copyright on all of the original material included in this paper. The authors also confirm that they have obtained permission, from the copyright holder of any third party material included in this paper, to publish it as part of their paper. The authors confirm that they give permission, or have obtained permission from the copyright holder of this paper, for the publication and distribution of this paper as part of the ICAS proceedings or as individual off-prints from the proceedings.