



HAL
open science

Determination of chloride threshold initiating corrosion: A new set-up taking the localized aspect of corrosion into account

Chantal Chalhoub, Raoul François, Myriam Carcasses

► To cite this version:

Chantal Chalhoub, Raoul François, Myriam Carcasses. Determination of chloride threshold initiating corrosion: A new set-up taking the localized aspect of corrosion into account. *Cement and Concrete Research*, 2019, 124, pp.105825. 10.1016/j.cemconres.2019.105825 . hal-02395954

HAL Id: hal-02395954

<https://insa-toulouse.hal.science/hal-02395954v1>

Submitted on 25 Oct 2021

HAL is a multi-disciplinary open access archive for the deposit and dissemination of scientific research documents, whether they are published or not. The documents may come from teaching and research institutions in France or abroad, or from public or private research centers.

L'archive ouverte pluridisciplinaire **HAL**, est destinée au dépôt et à la diffusion de documents scientifiques de niveau recherche, publiés ou non, émanant des établissements d'enseignement et de recherche français ou étrangers, des laboratoires publics ou privés.



Distributed under a Creative Commons Attribution - NonCommercial 4.0 International License

1 Determination of chloride threshold initiating corrosion: a new set-up taking the localized aspect of 2 corrosion into account

3 Chantal Chalhoub*, Raoul François, Myriam Carcassés

4 LMDC, INSA, UPS, Université de Toulouse, France

5 * Corresponding author: chantal.chalhoub@insa-toulouse.fr

6 ABSTRACT

7 In spite of much research invested in the study of concrete reinforcement corrosion induced by
8 chlorides, there is still no agreement on an accurate method for determining the chloride threshold
9 value initiating corrosion. The objective of this work is to present a new test set-up that considers the
10 localized character of corrosion initiated by chlorides. This approach is based on a physical separation
11 between the anode, contaminated with chlorides, and the cathode, which is chloride free. This
12 approach will allow to quantify the galvanic corrosion current, making it possible to determine, in a
13 second step, the chloride threshold values for corrosion initiation. The criteria for corrosion initiation
14 was a threshold corrosion current defined as a current that is independent of the cathode/anode
15 surface ratio. It was then important to test the influence of the geometric surface ratio on the galvanic
16 corrosion current. It was found that it is an important parameter that needs to be taken into account
17 when studying corrosion in the presence of chlorides. Preliminary results of threshold values were
18 determined based on this criterion for CEMI and for several types of steel surface conditions. The
19 preliminary results also give an idea of the influence of chloride contents on the galvanic corrosion
20 currents.

21

22 1.Introduction

23 Traditionally, concrete reinforcement corrosion induced by chlorides is initiated when the
24 chloride content reaches a certain threshold C_{crit} . After investing much time and effort in this field,
25 researchers have still not reached agreement on an accurate and reliable method for the determination
26 of this threshold value [1]. Corrosion initiated by chlorides is macrocell corrosion (also known as
27 localized or non-uniform corrosion). This means that the anodic (active steel) and cathodic (passive
28 steel) sites are distant from one another.

29 Two traditional electrochemical techniques are commonly used for analysing corrosion
30 initiation: measurement of the linear polarization resistance, and measurement of the reinforcement
31 potential, where a potential drop would indicate the start of corrosion.

32 The first electrochemical method, the measurement of linear polarization resistance of steel in
33 concrete, is supposed to provide quantitative information on corrosion kinetics, unlike the potential
34 measurements. It is based on polarizing the reinforcement in order to shift the corrosion system from
35 its equilibrium state. The polarization resistance obtained is then converted into corrosion current
36 density by means of the Stern-Geary equation [2,3], which was originally established for the uniform
37 corrosion state [4]. Unfortunately, application of the Stern-Geary [2] equation to localized corrosion
38 found in real structures is unsuitable since it is not fundamentally correct to apply the mixed potential
39 concept established by Wagner and Traud [5] when anode and cathode are some distance apart.
40 Several problems in understanding polarization measurements and their application to macrocell
41 corrosion have been reported [6,7]. In fact, the behaviour of the macrocell system has been found to
42 depend on the polarization direction (anodic or cathodic) and magnitude. Laurens et al. [8] proved that,
43 when a macrocell system was polarized cathodically, the polarizing current was spread over passive
44 areas. Conversely, it was spread over active areas in the case of anodic polarization. This means that, in
45 localized corrosion systems, the apparent linear polarization range is underestimated when this
46 technique is employed. Additionally, Elsener et al. [9] found that the response of a macrocell system is
47 not the same as that of a microcell system. Recently, Angst and Büchler [10] questioned the applicability
48 of the Stern-Geary equation for quantifying the corrosion rate using linear polarization resistance

49 measurements in the case of macrocell systems. All the arguments mentioned above show that the
50 linear polarization resistance measurement does not take account of the intrinsic localized aspect of
51 corrosion in concrete reinforcement. Consequently, it is not possible to apply this method to reinforced
52 structures in the aim of quantifying corrosion kinetics [11].

53 The second method employs a technique for corrosion initiation that is commonly used
54 because of its low cost and its ease of execution. The diagnosis of corrosion initiation cannot be made
55 with an absolute value of reinforcement potential [12,13] as presented in the ASTM standard C876-91
56 [14], where the absolute potential measurement is interpreted and expressed in terms of corrosion
57 risk. A better way is to monitor potential over time in order to identify corrosion initiation [12].

58 Several experimental studies were realized based on this approach. Recently, a RILEM technical
59 committee (TC) 235-CTC [15] was formed in order to realize an appropriate test method capable of
60 giving information related to C_{crit} with tolerable measurement uncertainty. However, its ultimate aim
61 was not achieved. Concrete samples (water/binder=0.45) embedding vertical steel bars were used. The
62 bars were chemically cleaned followed by a pre-rusting procedure in humid environment in order to
63 create a practice-related and reproducible steel type. The introduction of chlorides was realized with a
64 pre-drying procedure in a drying environment followed by an immersion in a 3.3% NaCl solution in order
65 to accelerate the chloride ingress. Yet, the test duration was found much longer than expected. The
66 open circuit potential of the rebars was monitored and the criteria of corrosion initiation was a potential
67 drop of at least 150 mV in a period less than 24 h with a condition that the potential remains at its level
68 or lower for a minimum period of 7 days in order to make sure that stable corrosion takes place. The
69 measured total chloride threshold values varied from 0.6% to 1.6% /wt. binder with an average value
70 of 1.05%.

71 An experimental protocol, developed by Angst et al [16], consists on taking a number of
72 samples from real reinforcing concrete structures where corrosion has not yet initiated and expose
73 them to controlled laboratory corrosion testing. The main advantage of this method is that it
74 guarantees real conditions regarding factors that significantly impact C_{crit} , such as the steel-concrete
75 interface, the type and the age of the concrete and the type and surface condition of steel. The method
76 also allows to prevent false corrosion initiation and steel bar effects. The corrosion initiation criteria
77 was based on the method developed by RILEM technical committee TC 235 [15].

78 Another experimental work, developed by Pacheco and Polder [17], was also based on this
79 RILEM Committee work. The test specimens were formed of ordinary Portland cement (PC) and ground
80 granulated blast furnace slag (CEMIII/B) cement with a water/binder ratio equal to 0.45 for both
81 formulations. The surface condition of the bars was as received steel with possible presence of
82 oxidation products on some areas. The critical total chloride contents of the PC specimens ranged
83 between 0.3 and 1 %/wt. binder with an average value of 0.56%.

84 V. Nygaard and Geiker [18] developed an experimental method that allows to accelerate
85 chloride ingress decreasing the time needed to initiate corrosion. The chloride ingress was realized by
86 a sample drying followed by their immersion in saline solution. The authors stated that there can be
87 adverse effects of the conditioning used, mainly for the drying part (such as the non-saturated pores
88 and/or coarsening of the pore system) which can lead to lower C_{crit} . In this case, the corrosion activity
89 of the bars was monitored by potentiostatic control. In fact, a current was applied to the steel
90 electrodes to maintain their fixed potentials and corrosion initiation was defined as an increase of the
91 applied current to more than 50 μ A. The critical chloride found on CEMI concrete samples
92 (Water/binder =0.45) ranged from 0.52 to 0.74 % . wt. binder. However, galvanostatic or potentiostatic
93 control prevents repassivation which can occur under site conditions. The polarization method is then
94 considered to be non-representative and conservative [15].

95 Garcia et al [19] used the same corrosion initiation criteria presented earlier and found, in case
96 of CEMI, C_{crit} values that ranged between 0.6% and 0.9% per weight of cement.

97 This technique, also implemented in others several studies [20–23], does not provide
98 any quantitative information about corrosion kinetics. Moreover, the results obtained by
99 Garcia et al. [19] indicate that it is no longer useful in cases of formulations with slag and
100 pozzolanic additives. It was found that, for formulations with high substitution levels of slag,
101 the potential values were very low from the beginning of the potential monitoring (between -
102 600 and -700 mV/SCE), despite the absence of corrosion, and that no potential drop occurred with
103 the initiation of corrosion. This implies that the detection of corrosion initiation using a potential
104 drop could be difficult in cases where the potential is highly negative, for example in slag
105 cements or in other binders containing sulfide [16].

106 It was therefore necessary to propose a new test protocol that would reproduce the localized
107 chloride-induced corrosion found in real structures. This test method consists on the same components
108 found in the other protocols discussed earlier (such as the steel bar surface condition, the alkaline
109 environment, the procedure to introduce and measure the chlorides and the exposure conditions) but
110 with the addition of another component which is the galvanic corrosion current. Hence, the test set-up
111 described here is based on a physical separation of the anode part, contaminated with chlorides, from
112 the cathode part, which is chloride free. In order to estimate corrosion rates and predict lifetime of
113 reinforced concrete structures subjected to chloride-induced corrosion, the macrocell current is of
114 main concern. This new experimental approach will allow the galvanic corrosion current to be
115 quantified, thus making it possible to determine in a forthcoming work the chloride threshold values
116 for corrosion initiation for all kind of binders including high slag contents. Preliminary results of
117 threshold values were determined based on a threshold corrosion current that is considered
118 independent of the surface ratio between cathode and anode. It was then important to test the
119 influence of the geometric surface ratio on the galvanic corrosion current. It was confirmed that it is an
120 important parameter that needs to be taken into account when studying corrosion in presence of
121 chlorides.

122 With this test, it is also possible to study the influence of several parameters on corrosion
123 propagation: anodic, cathodic, ohmic, geometric and environmental mechanisms. The preliminary
124 results presented in this paper provide an idea of how chloride contents and the nature of the steel
125 surface influence the galvanic corrosion currents.

126 2. Electrochemical background on the macrocell corrosion system

127 Corrosion initiated by chlorides is an electrochemical phenomenon involving two mechanisms,
128 one of oxidation and the other of reduction. The anode, where the oxidation of the steel takes place,
129 generates electrons needed for the reduction reaction of dissolved oxygen at the cathode. In the case
130 where the anode and cathode are spatially combined, the corrosion is said to be uniform and is also
131 known as microcell corrosion. In this case, the potential field is uniform and there is no current flowing
132 in the concrete volume.

133 On the other hand, when the anode and cathode are spatially separated, the corrosion is said
134 to be macrocell or non-uniform. This type of corrosion, also known as galvanic or localized corrosion, is
135 encountered in reinforced concrete structures exposed to aggressive agents such as chlorides. In fact,
136 the reinforcing steel in concrete is naturally protected against corrosion by a passivation phenomenon
137 consisting of the fast formation of a dense oxide film on the steel surface. Nevertheless, this passive
138 film may be locally destroyed by chloride ions, causing a local activation of the steel and leading to
139 macrocell corrosion conditions.

140 In macrocell systems, anodic and cathodic potentials at equilibrium are different, which leads
141 to a non-uniform electrochemical state of the steel with the presence of a potential gradient.
142 Consequently, an ionic current circulates through the interstitial solution of the concrete between
143

144 anodic (active) and cathodic (passive) areas. This ionic current is influenced by the electrical resistivity
145 of the concrete, which consequently affects the macrocell electronic current flowing through the
146 metallic network. This makes the electrical resistivity of the concrete a possible control factor of the
147 macrocell system.

148 A macrocell corrosion system can be defined as the electrical connection of two uniform
149 corrosion systems: one active, representing the anode, and the other passive, representing the
150 cathode, which results in their mutual polarization.

151

152 **3.Experimental test protocol**

153 The experimental set-up recreated localized corrosion by imposing a physical separation
154 between the anode and cathode, which allowed the galvanic corrosion current to be measured. This
155 was done by preparing two types of samples: the anode, representing the sample contaminated with
156 chlorides, and the cathode, representing the sample without chlorides. To avoid the diffusion phase of
157 chlorides and reduce the time needed for them to reach the steel surface, anodes were dried to
158 constant weight then soaked in saline solutions.

159 This two-piece test set-up enabled the galvanic corrosion current to be quantified, thus making
160 it possible to determine the chloride threshold values for corrosion initiation. It was also possible to
161 test the influence of several parameters and mechanisms on corrosion propagation, such as the
162 influence of anodic parameters and the ratio between cathodic and anodic surface areas (noted C/A
163 ratio). The size of the anode was chosen to be small despite the fact that, in reality, the anode forms
164 spontaneously on larger rebar surfaces. The reason behind this is to have an anode steel bar that is, as
165 much as possible, in an active state. In real structures, the C/A ratio is very high at the beginning of the
166 corrosion process because of the multiple layers of reinforcement bars that are still initially in the
167 passive state. For this reason, in the present test, a high C/A ratio, of 16, was chosen. Moreover, it was
168 important to choose a sufficiently large C/A ratio that is equal to 16 because lower C/A values may lead
169 to corrosion currents that are difficult to measure.

170

171 **3.1. Description of test specimens**

172 **3.1.1 Specimen characteristics**

173 The cathodic samples were cylindrical ($\phi 110 \times 220$ mm) with a cover of 5.2 cm. At the centre
174 of each sample was a 160 mm long Fe-500 ribbed steel bar 6 mm in diameter. The anodic samples were
175 also cylindrical ($\phi 33 \times 70$ mm) with a steel bar of 10 mm length and 6 mm diameter embedded at the
176 centre of each one, thus having a cover of 1.35 cm.

177 Two electrical wires were tin welded to each steel bar, one to the upper part and one to the
178 lower, leaving only the lateral surface of the steel uncovered. The upper wire was used to guarantee a
179 good electrical connection during electrochemical testing. Each wire was held in place by a hole made
180 in the middle of the upper and lower part of the plastic mould. The rebar was thus maintained in the
181 middle of the specimen. The lower wire was fixed to the hole of the base of the mould with a knot,
182 which was then covered in silicone.

183

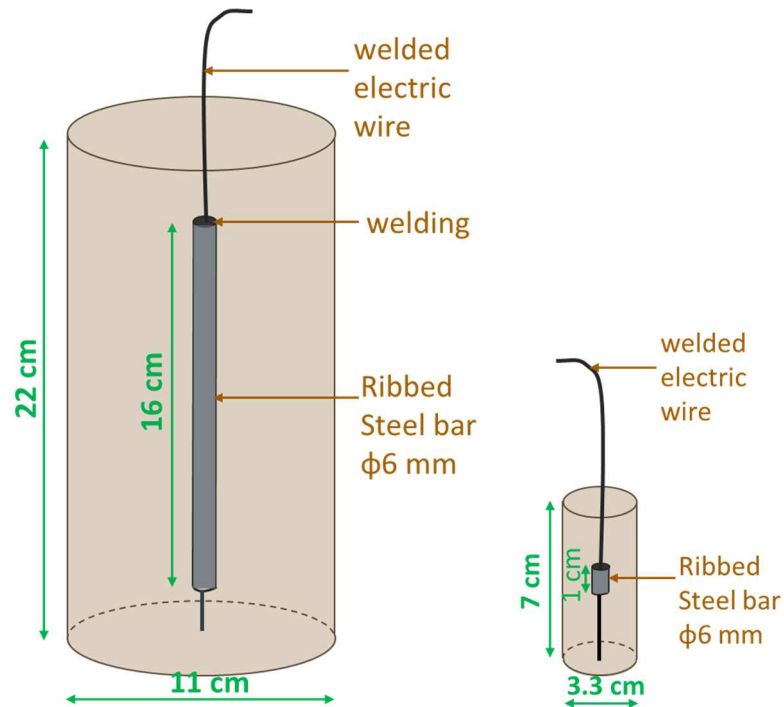

Fig. 1. Dimensions of the cathodic (left) and anodic (right) test specimens

184
185
186
187
188
189
190
191

3.1.2 Mortar composition and its characterization

The use of reinforced mortar specimens instead of reinforced concrete allowed small samples to be made without recourse to core cutting. The mortar formulation used and its characteristics are presented in Table 1 and Table 2, respectively. The water/cement ratio used was 0.55 and the sand/cement ratio was 2.75.

CEM I Mortar mixture	
Materials	Quantity (kg/m ³)
Siliceous sand 0/4	1408
CEMI 52.5 R (Lafarge factory)	512
Water	281.4
Water/Cement	0.55

Table 1. Mortar formulation

192
193

Characterization tests	CEMI					
	10 days		28 days		90 days	
Compressive strength (MPa) (NF EN 196-1)	59	$\bar{X}=56$ $\sigma=2$	65	$\bar{X}=66$ $\sigma=1$	78	$\bar{X}=75$ $\sigma=2$
	54		68		75	
	56		65		74	
Water porosity (%) (AFREM)	21.5	$\bar{X}=21.7$ $\sigma=0.20$	21.3	$\bar{X}=21.2$ $\sigma=0.34$	20.86	$\bar{X}=21.0$ $\sigma=0.15$
	21.7		21.5		21.06	
	22		20.7		21.22	
	20.15	$\bar{X}=20.11$	20.22	$\bar{X}=19.68$	17.16	$\bar{X}=16.73$

Chloride migration coefficient (10-12 m ² /s) (NtBuild 492)	19.79	$\sigma=0.24$	19.48	$\sigma=0.39$	17.02	$\sigma=0.52$
	20.38		19.33		16	
Electrical resistivity ($\Omega\cdot\text{m}$) (RILEM TC-154 EMC)	106	$\bar{X}=109$ $\sigma=3$	114	$\bar{X}=123$ $\sigma=9$	120	$\bar{X}=128$ $\sigma=8$
	111		132		135	

Table 2. Characterization results on the mortar obtained at 10, 28 and 90 days of curing age

194

195 3.1.3 Steel bar reinforcement types

196 It is essential to understand the effect of the surface condition of steel on rebar corrosion. In
197 fact, reinforcement bars are often covered with a layer of mill scale (high temperature phase formed
198 during the cooling of iron) which may or may not be combined with a layer of corrosion related to the
199 action of rainwater or formed during prolonged outdoor exposure on site.

200 The non-uniformity of mill scale could lead to the concept of weakest spot. The weakest spot
201 could be related to the geometry of the rebar such as the presence of ribs which can induce different
202 cooling kinetics during the industrial process. On the other hand, the weakest spot could be related to
203 damages after manufacture for instance during the handling or during the assembly of the bars on
204 construction site. It could also be related to size effect in casting process for instance the heterogeneity
205 of the steel/concrete interface.

206 If the weakest point is induced by the rebar damages or size effect, this limitation cannot be
207 resolved in a laboratory experimental test even if a bigger length of anode rebar was used. Knowing
208 that, in reality, the length of the bars is approximately 6m whereas the length of the bars used as
209 anodes, in experimental works, usually do not exceed 0.1 m.

210 However, if the weakest point is associated with the geometry, it is possible to resolve this issue
211 by using different types of steel surface conditions. For instance, it is possible to use a certain treatment
212 that eliminates the effects of formation of mill scale during the cooling of rebars by using an acid
213 cleaning technique followed with a heating treatment that allows the formation of a new layer of
214 corrosion products that is supposed to be more uniform than mill scale.

215 Four different types of steel surface were used in this study (Fig. 2):



Fig. 2. Different types of steel bars used: ARS, CS, CSPT and CSPH

- 216 • As Received Steel, “ARS”: steel without treatment presenting a non-uniform layer of mill scale, which
- 217 is the case for many reinforcement bars on site.
- 218 • Cleaned Steel, “CS”: steel cleaned with a chemical cleaning procedure based on standard ISO 8407
- 219 [24], which uses an acid solution to remove the mill scale layer. The weight difference of the steel bar
- 220 before and after the cleaning treatment was measured on 96 different bars and had an average value
- 221 of 2.2 μ mg with a coefficient of variation (CV) of 28.8%. This value could represent the weight of the
- 222 mill scale layer at the steel surface.
- 223 • Cleaned Steel Pre-oxidized by high Temperature, “CSPT”: steel cleaned then oxidized with a heat
- 224 treatment of 72 h at 400 °C in order to obtain a homogeneous layer of corrosion products having a
- 225 composition close to that of the mill scale found in the case of ARS bars, which is made up mostly of
- 226 magnetite with a little hematite. The weight difference after cleaning of the samples was measured
- 227 before and after the heat treatment on 48 different steel bars. The weight difference was around 0.67

228 mg (CV=38.4%) and represented the weight of the layer of corrosion products formed at the surface of
229 the steel bars during the heating treatment.

230 • Cleaned Steel Pre-oxidized by exposure to Humid environment “CSPH”: steel cleaned then oxidized
231 for two weeks in a humid environment (relative humidity=95%) in order to study a non-uniform
232 oxidation layer formed in the absence of mill scale.

233 The steel type abbreviations explained in this section are used in the rest of the paper. The weight of
234 the anodic steel bars was measured with a precision of 0.0001 g before the wires were welded, in order
235 to quantify the steel weight loss before and after corrosion.

236

237 3.1.4 Preparation of mortar samples

238 Once prepared and mixed, the fresh mortar was poured into the corresponding moulds in two
239 layers, each of them being vibrated for approximately 30 seconds in order to eliminate air voids. During
240 the vibration, it was important to keep the steel in the middle of the mould by pulling the electrical wire
241 vertically. After casting, the surface of the specimens was covered with a plastic cover to prevent the
242 evaporation of water. The upper wire was inserted in the hole of the cover and fixed with adhesive
243 tape. Then, the specimens were placed in a curing room where the relative humidity was approximately
244 95%. All the specimens were unmounted after 24 hours and then cured for 28 days in the same wet
245 curing room.

246

247 3.2. Processing of anodic specimens

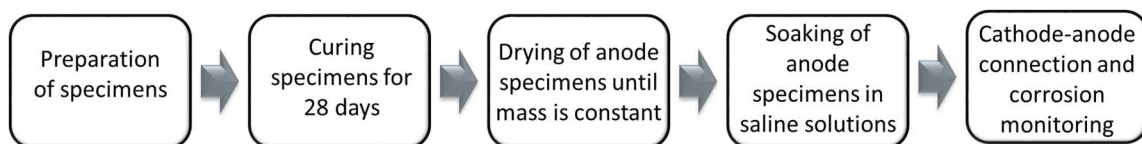

248
249 Fig. 3. Schematic representation of the specimen processing
250

251

252 3.2.1 Drying of anodic specimens

253 After the end of the wet cure, the anodic specimens were dried at a constant temperature of
254 45 °C and a controlled relative humidity of 25% until their mass was constant, i.e. until 2 successive
255 weighings before and after 24 hours in the oven did not differ by more than 0.05%. The temperature
256 was limited to 45 °C to avoid the destabilization of hydrates and cracking. The drying time necessary for
257 the stabilization of the mass of the anodes and consequently the extraction of all the existing water in
258 the connected pores was between 25 and 35 days (Fig. 4). The average volume of dried water was
259 calculated with equation (Eq. 1). It corresponded to 15.7% of the apparent total volume of the mortar
specimen and represented almost 75% of the water porosity of the formulation used.

$$260 \quad V_{dried} (L) = \frac{W_{dried}}{\rho_{Water\ meas}}$$

Eq. 1

261 W_{dried} : Weight of the water dried from connected pores determined by the mass difference found
262 when measuring the anodic sample before and after complete drying (g);

263 $\rho_{Water\ meas}$: Density of water measured experimentally at 20 °C, with a value of 995 g/L.

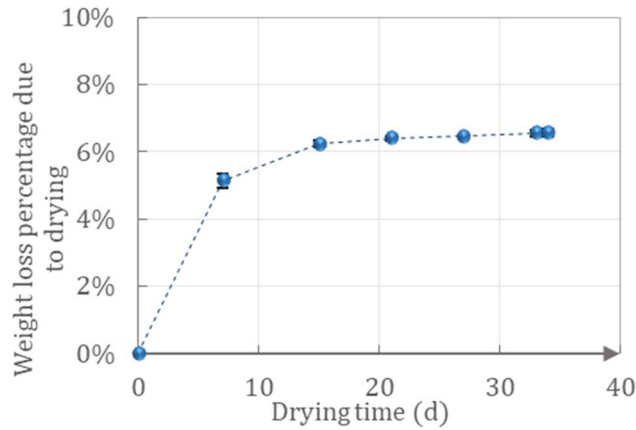

Fig. 4. Stabilization of the weight loss of anodes during their drying in the oven

264
265

266 During their drying period, anode specimens could be subjected to carbonation. It was then important
 267 to see if the anode specimens were carbonated during drying. For this reason, some dummy specimens
 268 having the same dimensions of the anode but without reinforcement, were dried in the same
 269 environment of the anode specimens. After more than one year of drying, phenolphthalein solution
 270 was sprayed onto the freshly cut surfaces of those samples in order to determine the carbonation
 271 depth. A solid purple coloration was observed on the entire surface indicating that there was no
 272 carbonation during the drying of anode samples.

273

274 3.2.2 Immersion of anodic specimens in saline solutions

275 After the end of drying, the chlorides were introduced by soaking the anodes in 1 L of sodium
 276 chloride solutions having controlled chloride contents using demineralized water. The electrical wires
 277 welded to the bars were coated with silicone to avoid chloride penetration into the samples through
 278 the wires. The samples were entirely immersed for 48 hours in saline solutions with 5 different
 279 concentrations of NaCl: 12.25, 22.75, 70, 140 and 280 g/L. Hence, a priori, known quantities of chlorides
 280 were present in the anode samples. Their quantities were also measured a posteriori, after the
 281 destruction of the specimens to check the corrosion state. On the other hand, the cathodes, which
 282 were chloride free, remained intact and could thus be reused.

283 5 reference samples identical to the anode samples but without steel bars were contaminated
 284 with the different saline solutions for a period of 168 hours. The weight of the samples was measured
 285 before and after soaking at different imbibition durations. After 48 hours of soaking, the weight of saline
 286 solution absorbed by the sample (W_{abs}) according to the initial weight of the sample ($W_{initial}$) had almost
 287 stabilized (Table 3). This means that a period of 48 hours of soaking is an optimal duration for the
 288 immersion of anode samples in saline solutions.

289

[NaCl] (g/L)	$W_{abs} / W_{initial}$ (%)						
	Imbibition duration (h)						
	0	5	24	48	72	96	168
280	0%	6.9%	7.6%	7.7%	7.7%	7.7%	7.8%
140	0%	7.0%	7.2%	7.2%	7.2%	7.2%	7.3%
70	0%	7.0%	7.0%	7.0%	7.0%	7.1%	7.2%
22.75	0%	6.6%	6.6%	6.7%	6.7%	6.7%	6.8%
12.25	0%	6.9%	6.9%	6.9%	6.9%	7.0%	7.1%

Table 3. Weight percentage of absorbed saline solution according to duration of soaking

290 **3.3. Methods for corrosion assessment**

291 At the end of the corrosion test, a steady state polarization test was performed on samples. This test is
 292 not presented and not used in this paper but will be exploited in a forthcoming work. Then, the chloride
 293 contents were determined for all the anode samples. All of the CS, CSPT and CSPH and some of the ARS
 294 specimens were used for the characterization of the steel/mortar interface. Most of the ARS specimens
 295 were used for visual and optical inspection and gravimetric measurements. Each of the analysis
 296 methods presented in Fig. 5 is detailed below.

297

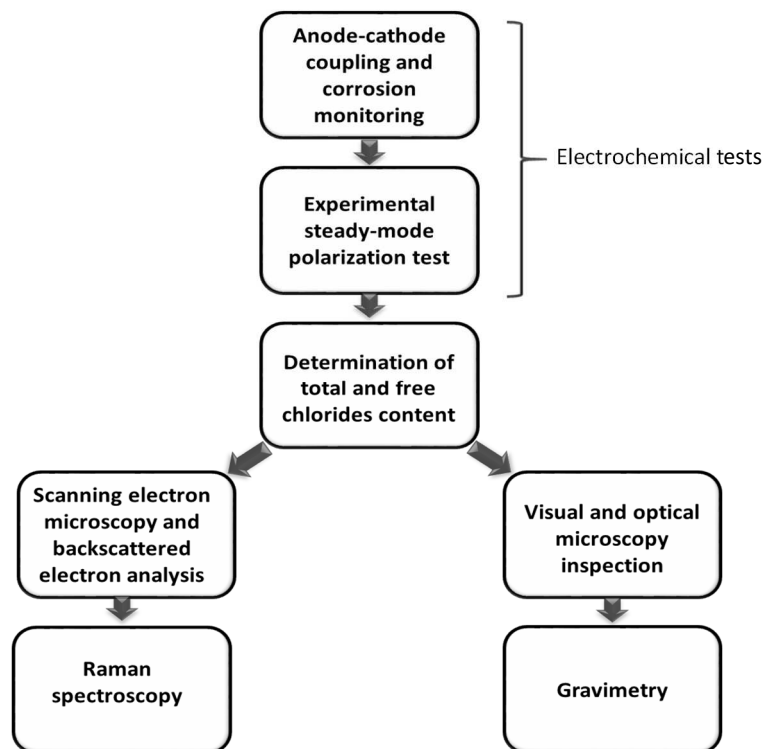

298

299

Fig. 5. Summary of the corrosion analysis methods used

300 3.3.1 Anode-cathode coupling and measurement of galvanic corrosion current

301 After two days of immersion in the saline solution, each anodic specimen was placed, with the
 302 corresponding cathode, in a sodium hydroxide solution (NaOH). The anode and cathode samples were
 303 separated by a distance of 30 cm, leaving 1 cm of the anode and 3 cm of the cathode not immersed in
 304 the alkaline solution. The pH and electrical conductivity of the sodium hydroxide solution were
 305 measured with a pH meter and a conductivity meter, respectively (Table 4). Since NaOH reacts with
 306 carbon dioxide from the air, each solution prepared for the test was renewed after 7 days in order to
 307 maintain the same concentration and thus the same pH.

Age (days)	pH	Electrical conductivity (mS/cm)
0	12.31	57.1
7	12.21	26.42
7	12.20	27.47

308

Table 4. pH and electrical conductivity of NaOH solution measured at different ages

309 The anode and cathode samples were connected by a potentiostat controlled by EC-Lab®
 310 software using the ZRA (Zero Resistance Ammeter) electrochemical technique to measure the galvanic
 311 coupling current between them (Fig. 6). The measurement of the current was maintained for 7 days in
 312 order to reach the steady state (stabilization of the measured galvanic current). All the electrochemical
 313 experiments were carried out at a constant temperature of 20 °C in a controlled room.

314 It is important to note that, if the anode was left alone after chloride soaking, intrinsic localized
 315 corrosion due to chlorides led to non-uniform corrosion on the anode (called inside macrocell), which
 316 was assumed to be negligible in comparison with the galvanic corrosion. Further research will be
 317 needed to assess the proportion of inside macrocell corrosion of the anode in comparison with the
 318 galvanic current measured.

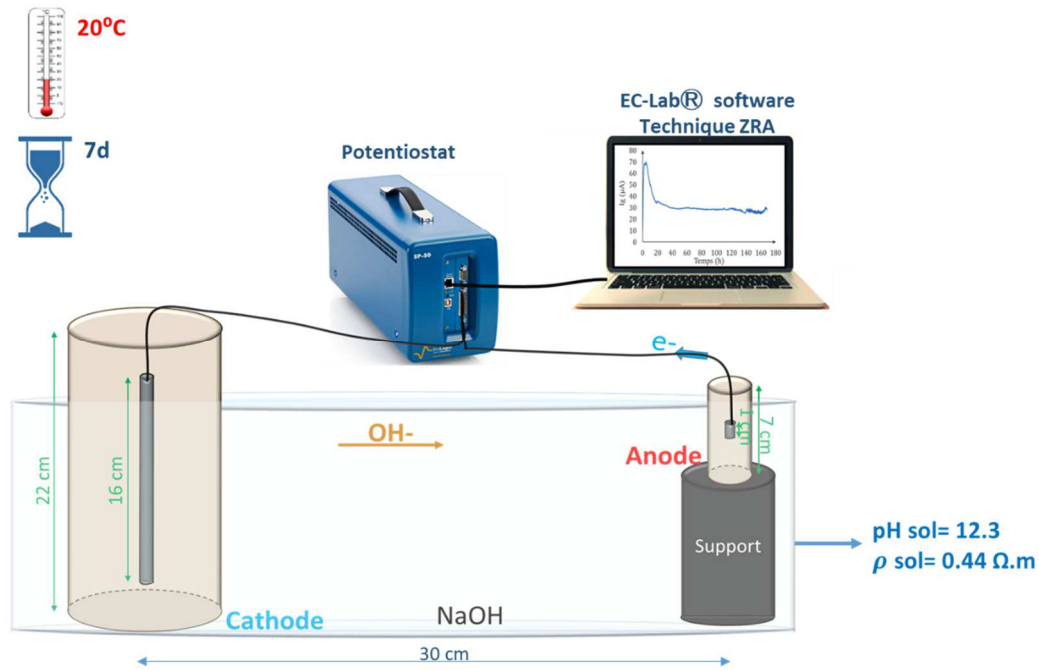

319
 320

Fig. 6. Cathode-anode coupling and measurement of the galvanic current

321 This two-specimen system allowed the galvanic current between anodic and cathodic areas to
 322 be quantified, which has not been possible in the single-specimen systems developed in the literature
 323 [15]. This galvanic corrosion current was evaluated according to the chloride contents and the nature
 324 of the steel surface.

325 The potentials of the anode and cathode were measured before the two samples were
 326 connected and the potential was tracked for one hour after the samples had been disconnected at the
 327 end of the corrosion test. Generally, the potentials measured with respect to a reference electrode
 328 located on the surface of the concrete do not represent the real potential of the reinforcement. These
 329 potentials depend on the position of the reference electrode because of different phenomena such as
 330 junction potential at all interfaces, gradient of concentration in the embedding mortar, etc. In this test,
 331 the geometry of the anode specimens and cathode samples was the same and the samples were
 332 symmetrical, with a constant cover thickness regardless of the position of the reference electrode.
 333 Hence, it was possible to compare the potential measurements.

334

335 3.3.2 Determination of total and free chloride contents per mass of cement

336 Total and free chloride (Cl) contents were measured at the end of the corrosion test in all of
 337 the anode samples to relate the measured chloride levels to the experimental galvanic currents. The

338 dissolution of powders for the determination of total chlorides (free and bound) was carried out
 339 according to standard NF-EN-14629 [25] and the preparation of solutions for the free chlorides followed
 340 the procedure recommended by GranDuBé [26]. The determination of chlorides in mortar powder
 341 requires a sample weighing between 1 and 5g. Thus, mortar was taken at the level of the steel bar after
 342 splitting the sample in the middle and removing a thickness of 5 mm of mortar from either side (Fig. 7)
 343 to obtain almost 6 g of powder. Approximately 2 g was used for the quantification of total chlorides and
 344 4 g for the free chlorides. The volumetric analysis was performed with the Ti amo software by
 345 precipitation with a silver nitrate solution.

346 In order to confirm whether the soaking procedure led to the estimated chloride contents in
 347 the vicinity of the rebar, these measurements were also made on 6 reinforced reference samples
 348 directly after 48 hours of soaking, without their coupling with a cathode (hence avoiding possible
 349 chloride accumulation induced by the potential gradient resulting from the corrosion test). These
 350 control specimens were soaked in 5 different saline solutions with the 5 concentrations mentioned in
 351 part 3.2.2, and in demineralized water. To make sure that this sampling method was reliable and
 352 repetitive, we also measured the free chlorides on 4 g of powder with the GranDuBé method, then the
 353 remaining chlorides, which represented the fixed chlorides, with the NF-EN-14629 standard. The results
 354 presented in Table 5 show that the sum of the free and fixed chlorides was almost equal to the level of
 355 total chlorides.

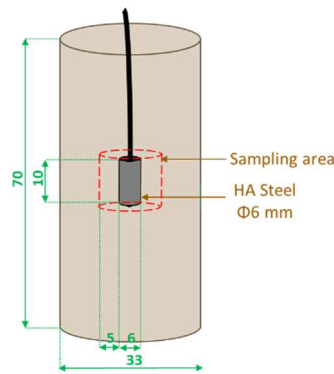

Fig. 7. Sampling area for the determination of chloride content (dimensions in mm)

356
357

358

	Experimental results (%/wt. cement)				calculation
	2 g of powder	4 g of powder	4 g of powder		Free Cl + Remaining fixed Cl
[NaCl] (g/L)	Total Cl (NF-EN- 14629)	Free Cl (GranDuBé)	Free Cl (GranDuBé)	Remaining fixed Cl (NF-EN-14629)	
0	0.09	0.03	0.03	0.06	0.09
12.25	0.29	0.16	0.17	0.12	0.29
22.75	0.43	0.30	0.28	0.12	0.41
70	1.03	0.89	0.88	0.18	1.05
140	2.80	2.59	2.50	0.31	2.81
280	5.03	4.68	4.69	0.38	5.07

359

Table 5. Application of the titration procedure on 6 reference samples

360 Knowing that the total chlorides are the sum of free and fixed chlorides, the shift from total to
 361 free chlorides could also be theoretically achieved using adsorption isotherm equations, which are
 362 empirical relations between the concentrations of a solute on the surface of an adsorbent and the
 363 concentration of the solute in the liquid with which it is in contact. The relationship between bound
 364 and free chlorides can be described by the Freundlich isotherm for high free chloride concentrations
 365 (Fig. 8). This relation (Eq. 3) is often used to describe isotherms because it correlates well with the
 366 experimental data.

367 $\text{Fixed Cl} = \alpha \text{ Free Cl}^\delta$ Eq. 2

368 With:

- 369 • Fixed Cl (%/wt. cement): Quantity of bound chlorides in the solid phase;
- 370 • Free Cl (%/wt. cement): Quantity of free chlorides in the pore solution;
- 371 • α and δ : Empirical coefficients.

372 The empirical coefficients are determined by fitting the Freundlich equation (Eq. 3) with the results
 373 obtained with the reference samples mentioned above, giving $\alpha=0.2$ and $\delta=0.4$ with a correlation
 374 coefficient of 0.98.

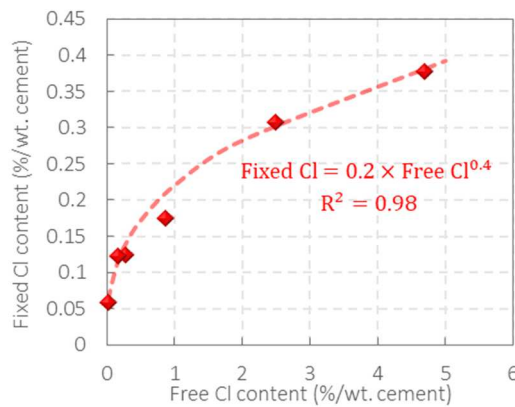
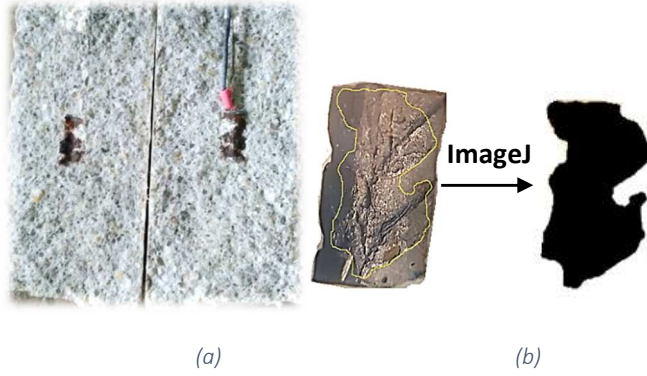

Fig. 8. Freundlich isotherm for the fixation of chlorides after 48 h in the case of the formulation presented in Table 11.

375

376 3.3.3 Visual and optical microscopy inspection

377 Once the anode had been split in the middle, it was simple to remove the steel. Then, the steel
 378 bar could be observed visually and with a microscope to detect the presence of corrosion products (Fig.
 379 9-a). The steel bar was then cleaned to remove all the corrosion products at the steel surface, following
 380 the ISO 8407 standards [24]. This cleaning method consists of light mechanical cleaning treatment
 381 combined with a chemical cleaning procedure using a solution of hydrochloric acid, antimony trioxide
 382 and tin (II) chloride. The steel was then directly observed with a microscope and 4 images were taken
 383 on 4 different sides of each sample in order to cover the whole cylinder. The area of the corroded steel
 384 surface was estimated on the images using ImageJ software (Fig. 9-b), which is an open source image
 385 processing program designed for scientific multidimensional images. The error involved when moving
 386 from a 3D object to 2D images was considered negligible even though the diameter of the steel bar is
 387 small (6 mm).



388
389

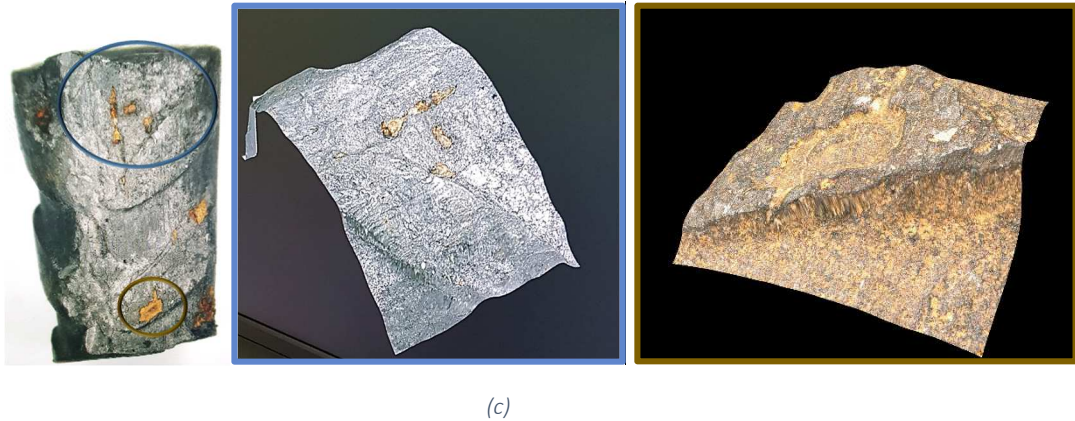

390
391
392
393

Fig. 9. (a) Splitting of the anode and visual detection of corrosion products. (b) Image processing of 1 side of a steel bar using ImageJ. (c) 3D observation with KEYENCE digital microscope of a steel bar corroded for 70 days

394 3.3.4 Gravimetric measurements

395 After the cleaning treatment and the microscopic inspection, the steel was weighed. The
396 difference between the initial mass (weight of the steel measured before mortar casting) and the final
397 one (weight after experiment and cleaning) gave the total mass loss of the steel. However, it was
398 important to exclude the metal loss resulting from cleaning. This was determined using 96 different
399 control specimens of steel bar. The average mass loss of the control specimens was around 2.23 mg
400 (Coefficient of Variation CV=28.8%), which reflected the mass lost by test specimens in the cleaning
401 procedure. Gravimetric measurements were only performed on ARS steel, since all of the CS, CSPT and
402 CSPH and some of the ARS specimens were used for the characterization of the steel/mortar interface.
403 Hence, there was no need to correct the mass loss to take account of that associated with the pre-
404 cleaning and pre-corrosion treatment. The steel mass loss resulting from the polarization test, when
405 realized, was also calculated using Faraday's law and subtracted from the total weight loss.

406 4. Results and discussion

407 4.1. Experimental macrocell corrosion current

408 4.1.1 Determination of the average corrosion current

409 As mentioned previously, the localized aspect of corrosion initiated by chlorides was even
410 observed on the small anode (Fig. 9). This means that the anode was partially active and therefore
411 behaved as a localized corrosion system. Consequently, it was necessary to separate the three types of
412 current presented in Fig. 10, where I_g is the measured corrosion current exchanged between anode
413 and cathode, I_a is the corrosion current exchanged between active and passive zones of the anode, and
414 I_{micro} is the microcell corrosion current at anodic sites of the anode which was considered negligible
415 because of the polarization of the anode during the corrosion test [11].

416 In a first approach, I_a was neglected because the passive area in the anode, also called the
 417 internal cathodic area, was much smaller than that of the external cathodic area, i.e. the passive area
 418 at the cathode. Further developments will be done to characterize this internal current I_a .

419 In the anode-cathode coupling tests, the galvanic corrosion current I_g was measured for 7 days.
 420 Fig. 11 shows the tracking of the measured corrosion current over time. Two main values of corrosion
 421 currents were considered: the instantaneous current at 7 days and the average current $I_{g,avg}$ calculated
 422 from the integral of the current signal over a duration of 7 days. However, since the average current is
 423 more representative of the corrosion process, this value is used in the rest of this paper.

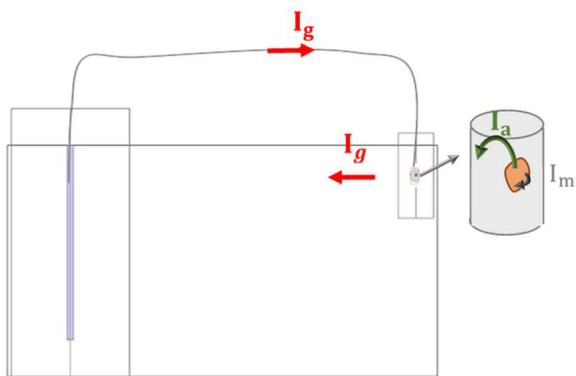

Fig. 10. Simplified schematic illustration of anode-cathode coupling showing the different types of currents

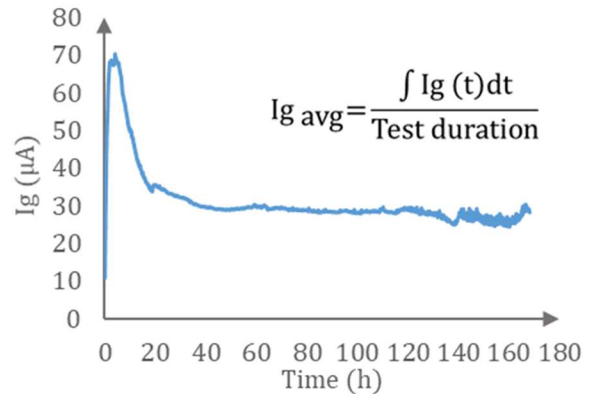
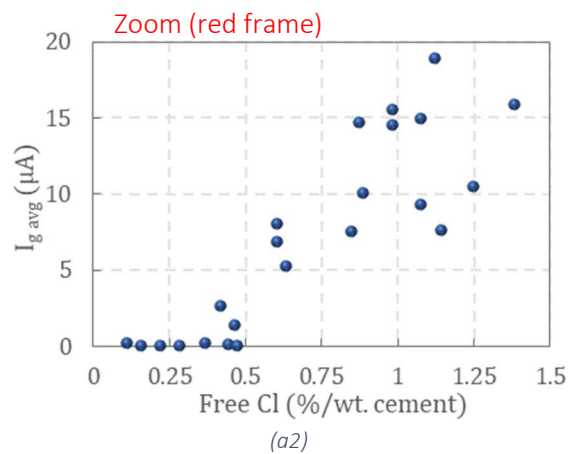
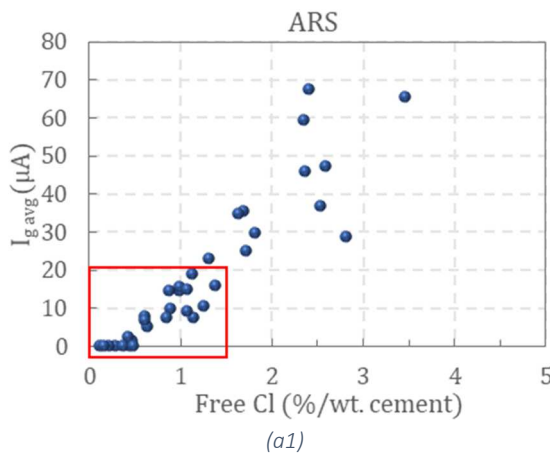

Fig. 11. Monitoring of a galvanic current measured between the anode and cathode samples

424
 425 4.1.2. Influence of chloride content and steel surface condition on galvanic corrosion current

426 Fig. 12 presents the average corrosion currents, $I_{g,avg}$, measured when connecting the anode
 427 and cathode according to the free chloride levels expressed in %/weight of cement and calculated from
 428 the measured total chloride contents using the isotherm presented in Fig. 8. The results are presented
 429 for the 4 types of steel described in section 3.1.3.



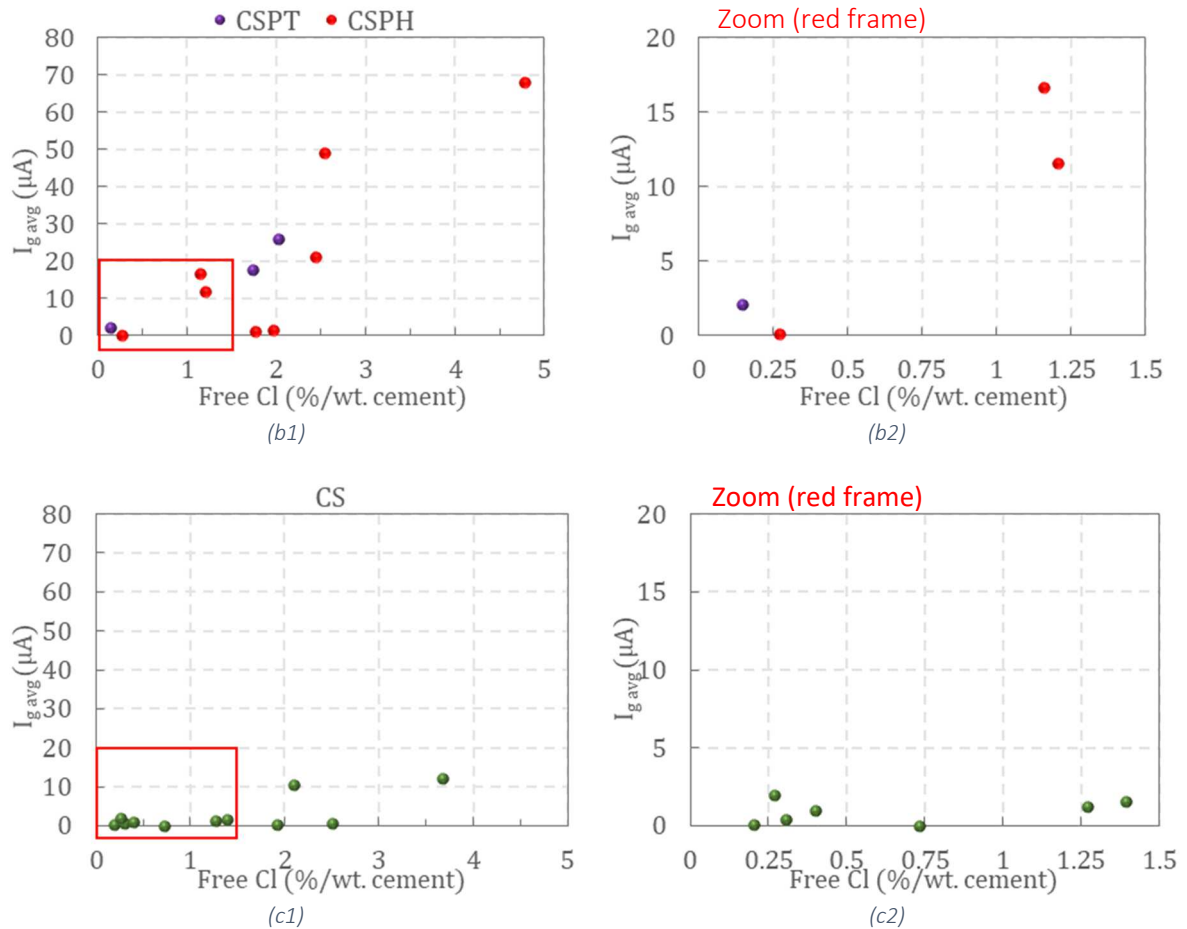

Fig. 12. Average corrosion currents according to free chloride contents (a1-2) As Received Steel; (b1-2) Cleaned Steel Pre-oxidized by high Temperature and Cleaned Steel Pre-oxidized in a Humid environment and (c1-2) Cleaned Steel

430

431

432

433

434

435

436

437

438

439

440

441

442

443

444

445

446

An increase of the corrosion current with the chloride level was observed for the case of as received steel, cleaned steel pre-oxidized in a humid environment, and cleaned steel pre-oxidized with high temperature. The similarity in the composition of the mill scale layer found on the as received steel and the layer of corrosion products formed on cleaned pre-oxidized steel could explain the resemblance of behaviour between these 3 types of steel. The non-uniformity of these layers may justify the presence of some scatter in the results obtained. Ghods and al. [27] found that the presence of micro cracks in the mill scale layer could lead to cavernous corrosion, which could partially explain the dispersion of the chloride threshold values for steel bars with presence of mill scale.

In contrast, the corrosion currents obtained for cleaned steel were weak compared to the results obtained with the other 3 types of steel. Yet, only for chloride levels higher than 2%, $I_{g,avg}$ became significant and above 10 μA (samples CS9 and CS11). Nevertheless, Fig. 13 shows that the currents measured in the case of high chloride contents were negligible during the first few days or hours and then increased sharply. This could be attributed to a time being necessary for chlorides to diffuse through the passivation layer formed on the cleaned steel. It should be noted that the average current for those 2 test pieces was also calculated by dividing the current signal surface by the total test duration.

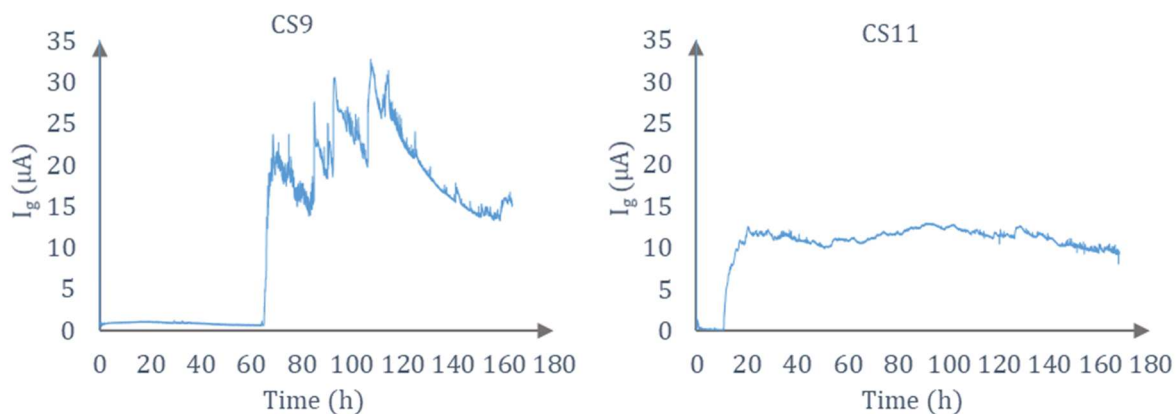

Fig. 13. Corrosion current measured in the case of cleaned steel for samples CS9 and CS11

447
448
449

The results obtained on the different steel surface samples allowed to make the assumption that the oxides formed on steel in the absence of mill scale (case of cleaned steel) are less porous to chloride ingress than those formed in the presence of mill scale (case of as received steel) and those formed on cleaned pre-oxidized steel.

454
455
456
457
458
459
460
461

This result is consistent with the work of E. Mahallati et al. [28] who studied the impact of the presence of mill scale on steel bars using cyclic polarization experiments. It was found that the formation, development and maintenance of the passive layer was determined by the accessibility of the metal cations to combine with oxygen and hydroxide ions. Hence, the mill scale layer could create an obstacle disrupting the formation of the passive layer. Horne et al. [29] also showed that the amount of portlandite near the reinforcement was almost 30% higher in the case of polished steel than in the case of steel with a mill scale layer. This phenomenon could have the effect of enhancing the buffering capacity of concrete at the steel-concrete interface.

462
463
464

A similarity is observed between the results obtained in case of ARS, which has a non-uniform surface condition, and the CSPT, which has a more uniform surface condition. This would indicate that the presence of a weakest point is not only related to the presence of ribs.

465 **4.2. Nature of corrosion products**

466 **4.2.1 SEM observation and BSE results**

467 A Scanning Electron Microscope (SEM) JEOL JSM 6380 operating in Backscattered Electron
468 (BSE) mode was used to study the steel-mortar interface. A Bruker Energy Dispersive Spectrum analyzer
469 (EDS) was used to quantify Iron (Fe in blue), Oxygen (O in red) and Chloride (Cl in green) in the
470 observation zones along an analytical line. Fig. 14 and Fig. 15 show examples of SEM images at the
471 steel-mortar interface for CSPH and CS anode samples, respectively. The analysis is then displayed as a
472 graph in which the horizontal axis represents the distance from the starting point of the analytical line
473 and the vertical axis characterizes the normalized mass percentages reflecting the Fe, O and Cl content.
474 The thickness of the steel-mortar interface layer was also measured and the maximum thickness of the
475 non-uniform layer was recorded for each steel type (Table 6).

476 The elementary composition analysis of the interface in ARS, CSPT and CSPH samples revealed
477 the presence of chlorides in the corrosion products. Furthermore, the Cl-containing corrosion deposits
478 were circular and located at the steel/oxide interface. This means that the chloride ions penetrated
479 through the oxide film formed on the surface of the bars to produce a chemical compound composed
480 of Cl, Fe and O. On the other hand, in CS samples, the thickness of the layer formed on the surface of
481 the steel was less than 50 nm. Therefore, it was not possible to quantify the elements formed at the
482 interface even with magnification higher than 500x.

Steel type	ARS	CSPT	CSPH	CS
Maximum thickness of the steel-mortar interface layer	100 μm	90 μm	300 μm	<50 nm

483

Table 6. Maximum thickness of the steel-mortar interface layer measured on anode samples

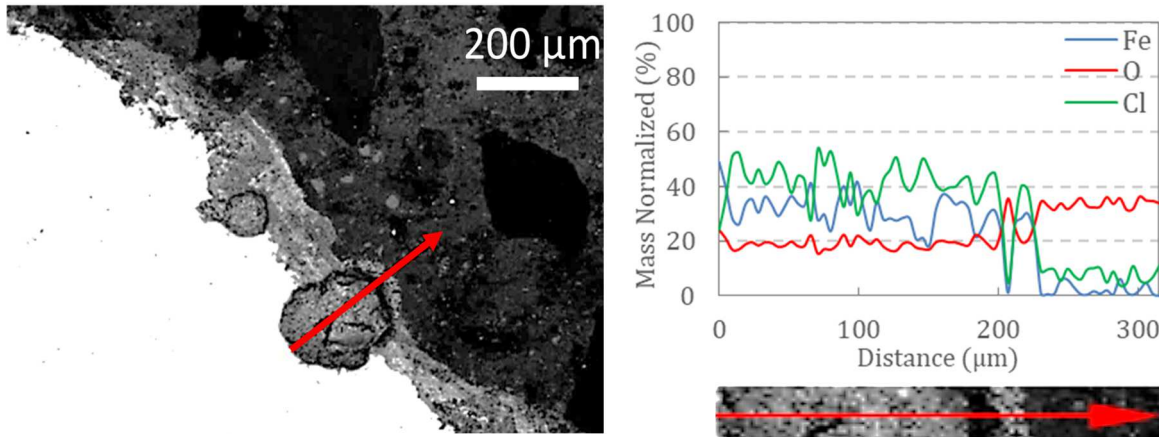

Fig. 14. Example of SEM observation and BSE analysis on a CSPH anode sample (magnifications: 110x)

484

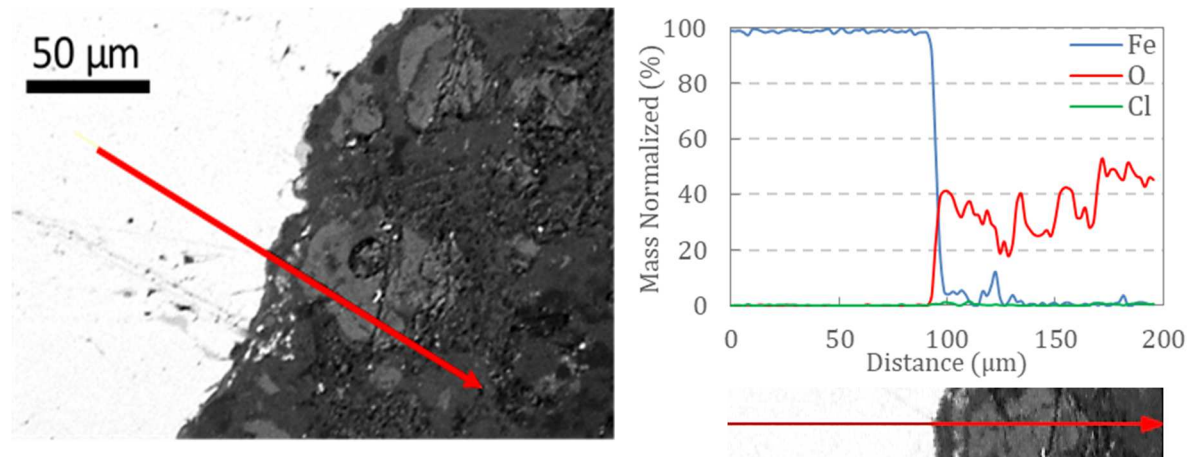

Fig. 15. Example of SEM observation and EDS analysis on a CS anode sample (magnifications: 500x)

485

4.2.2 Raman results

487

The corrosion products present at the steel/mortar interface were identified by Raman micro-

spectroscopy with a Horiba spectrometer at the CEA lab at Saclay, France. The microanalyses in this

study were performed with the 100x objective using the green visible radiation wavelength of 532 nm.

Over the entire optical path and the detection system, the spectral resolution was about 2 cm^{-1} . Spectra

were calibrated by means of a silicon crystal. The excitation laser power was filtered at 1% (acquisition

time: 300s) then 10% (acquisition time: 20s) in order to avoid potential thermal transformation of

sensitive iron oxides and (oxy)hydroxide [30,31]. Finally, the spectra were acquired and processed using

the LabSpec software and the phases were identified by comparison with spectra existing in the

literature [30,32–34]. Raman analysis was not possible in the case of CS samples because of the very

thin layer of oxides. Fig. 16 summarizes the corrosion products that were found in the Raman analysis.

In this figure, it can be seen that some Cl-containing corrosion products (akaganeite and iron

hydroxychloride $\beta\text{-Fe}_2(\text{OH})_3\text{Cl}$) were found at the steel/mortar interface on the steel side, which could

explain the presence of the circular shapes containing Cl that were observed and analysed with the

489

500 SEM. The hematite and magnetite may have been corrosion products resulting from the pre-corrosion
 501 process carried out before casting.

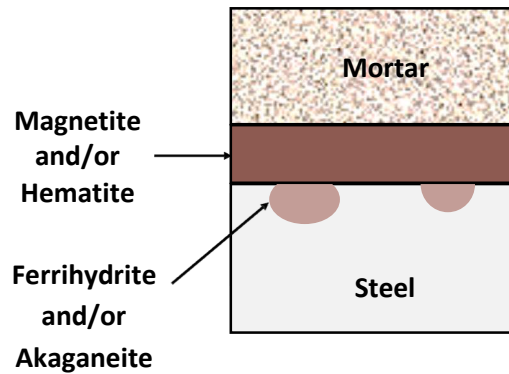

502

503 *Fig. 16. Summary of the corrosion products found on CSPT and CSPH samples*

504 **4.3. Gravimetric and surface measurements**

505 The corrosion current, $I_{Faraday}$, could be calculated theoretically from the measured loss of steel
 506 mass, using Faraday's law (Fig. 17). The mass loss of test specimens from the cleaning procedure and
 507 the steel mass loss resulting from the polarization test, when realized, were subtracted from the total
 508 weight loss. Looking at Fig. 17 we can see that the calculated currents deduced from the mass loss were
 509 slightly higher than the average galvanic currents, $I_{g, avg}$, measured in the experiment between anode
 510 and cathode.

511 This mass gap can be explained by our inability to measure the internal macrocell corrosion
 512 current I_a of the anode. Despite the scatter between the two values, the measured and calculated
 513 currents showed the same trend and were relatively close, which means that I_a was relatively
 514 negligible. An increase was also observed in the active steel surface measured after 7 days of corrosion
 515 with the free Cl levels (Fig. 18).

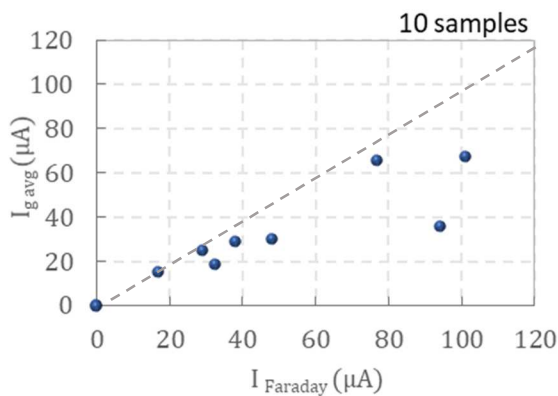

516 *Fig. 17. Measured corrosion currents versus calculated
 517 currents with Faraday's law*

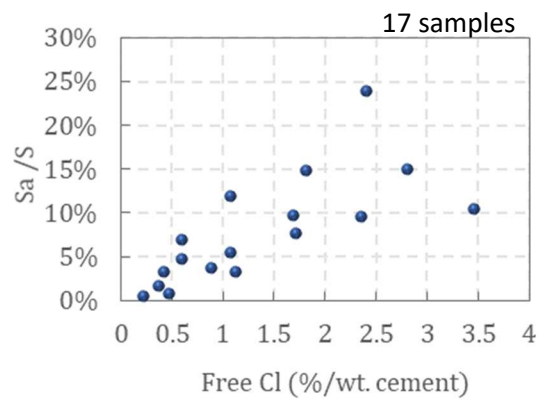

518 *Fig. 18. Measured corroded surface area percentages
 519 according to free chloride contents*

516

517 The experimental protocol presented in this work is based on the quantification of galvanic
 518 corrosion current for a C/A ratio sufficiently large that is equal to 16. This method allows to determine
 519 the chloride threshold values based on a threshold corrosion current that is independent of the area of
 520 passive steel. This current is defined as a current that does not change when the C/A ratio is higher than

521 16. In other words, the chloride threshold value was associated with a corrosion state that is the same
522 whether this ratio is 16 or higher.

523 Knowing that the corrosion current can be influenced by the cathode/anode surface ratio, it
524 was crucial to study the effect of this geometric parameter. In the next section, the influence of this
525 ratio is studied and the threshold current is fixed which allows to determine the chloride threshold
526 values of the results presented earlier (part 4).

527

528 5.Cathode/anode ratio "C/A"

529 The C/A ratio is generally defined as the fraction representing the surface area of passive steel
530 divided by that of active steel. On real structures, the formation of new anodic sites linked to chloride
531 ingress will lead to a decrease of the C/A ratio, which is initially very high. It is thus very important to
532 characterize the relationship between the geometric C/A ratio and the corrosion current I_g .

533 Several authors have studied the impact of this factor on the galvanic corrosion current. Warkus
534 and Raupach [35] studied experimentally and numerically the influence of the C/A ratio by changing
535 the amount of passive reinforcement in chloride-free part of reinforced structures. They found that
536 increasing the cathodic area leads to an increase in macrocell current.

537 Considering that in the initiation stage of corrosion C/A ratios are extremely high, it was crucial
538 to determine, in this work, the galvanic corrosion current, in case of very large cathodic area. It is
539 important to recall that all the corrosion measurements made up to now were linked to a predefined
540 geometric factor, the C/A apparent ratio, which was equal to 16. To reach very high C/A ratios, a
541 concrete wall was used to represent the cathodic part. The dimensions of the wall are presented in Fig.
542 19 and its formulation is given in Table 7. The wall was a concrete parallelepiped of 75x20x100 cm
543 containing 18 embedded steel bars of 12 mm diameter: 10 horizontal bars each having a length of 70
544 cm and 8 vertical bars having a length of 102 cm with 5 cm emerging from the concrete. The network
545 of frames was completely electrically disconnected but could be electrically connected from the
546 outside. The anode was placed in a PVC pipe containing a sodium hydroxide solution that was
547 connected to the wall allowing the ionic current to circulate. Smaller C/A ratios were also tested. In fact,
548 each anode was connected to 3 cylindrical cathodes ($\phi 11 \times 22 \text{ cm}^3$) with three different lengths of steel
549 (1, 5 and 16 cm) embedded in them so as to test C/A ratios of 1, 5 and 16 respectively.

550 Then, the anode was electrically connected to the steel bar(s) of the wall, connecting a different
551 number of bars each time, with different lengths presenting surface area ratios from 200 to 2950. Ten
552 different tests were carried out using 10 different anodes that were geometrically identical but had
553 been soaked in different concentrations of sodium chloride. Current measurements were made using
554 an Agilent multimeter and the values of the currents were recorded after they had stabilized to a
555 steady-state condition.

556

Cement	Type	CEM I 52.5 N CE CP2 NF
Sand	Type	0/4R ALL SIL CE
Gravel	Type	4/10 SR ALL SIL CE
Water/Cement		0.55
Sand/Cement		2

557 *Table 7. Formulation of the concrete wall.*

558

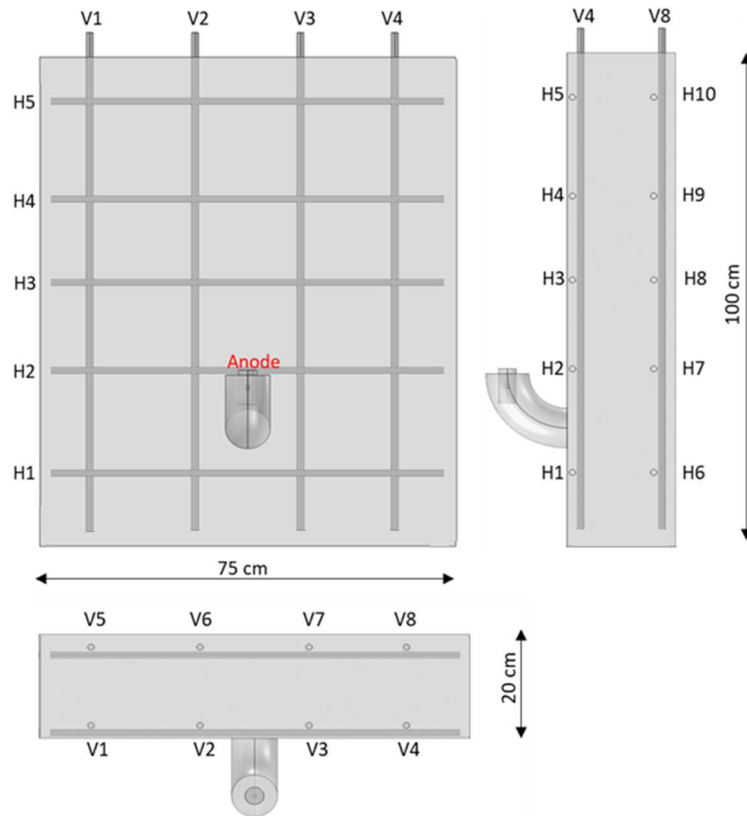

Fig. 19. Description of the concrete wall

560
561

562 It must be noted that the C/A ratios are presented, in this work, in terms of apparent ratios.
563 The effective C/A ratios are based on the real anodic areas measured after splitting the samples
564 presenting even higher ratios. Fig. 20 presents the currents measured for different C/A ratios for
565 different free Cl levels. The free chloride levels of the samples tested are shown in the legend of the
566 graph and are expressed in %/weight of cement. The results shown in Fig. 20 indicate that, for the same
567 active surface area, an increase of the passive area led to an increase of the corrosion kinetics. This
568 allows to conclude that an increase in the C/A ratio leads to an increase in the corrosion current, which
569 is in agreement with the localized corrosion concepts mentioned above.

570 In fact, for a given active surface area mobilized for the anodic reaction, the intensity of the
571 corrosion current is a function of the passive surface area mobilized for the cathodic reaction. This
572 means that the larger the passive area is, the stronger is the corrosion anodic current [11]. Moreover,
573 the experimental results show that the current growth rate decreases with increasing cathodic surface
574 area, which could mean that the current will reach its maximum value and stabilize for a certain C/A
575 ratio. Thus, it can be reciprocally concluded that the corrosion currents are high at the beginning (when
576 the C/A ratio is high) and fall continuously when the anodic surface increases (when the C/A ratio
577 decreases). The maximum corrosion current and the threshold stabilization ratio are associated with
578 the chloride levels. For Cl⁻ levels lower than 1%, the C/A ratio does not have much influence on corrosion
579 currents. The maximum corrosion current is also a function of the electrical resistivity of the wall. This
580 parameter will be studied in a further step of the research.

581 Looking at the results obtained, we can assume that for “low” C/A ratios, corrosion is
582 cathodically controlled. This means that corrosion current depends on dioxygen availability which is, in
583 our case, a function of the size of cathode. On the other hand, for “high” C/A ratios, corrosion current
584 is limited by the steel consumption, which is a function of the chloride content. An ohmic control of

585 corrosion is also present in this case because, when the C/A ratio increases, the cathode becomes more
586 distant from the anode.

587 With this experiment, given the small size of anode and the large cathodic area, it was possible
588 to test very high apparent C/A ratios compared to the ones studied by other authors. It was also possible
589 to experimentally test at least 14 different C/A ratios for each anode specimen. This means that, this
590 set-up makes it possible to determine galvanic currents for different C/A and different chloride
591 contents.
592

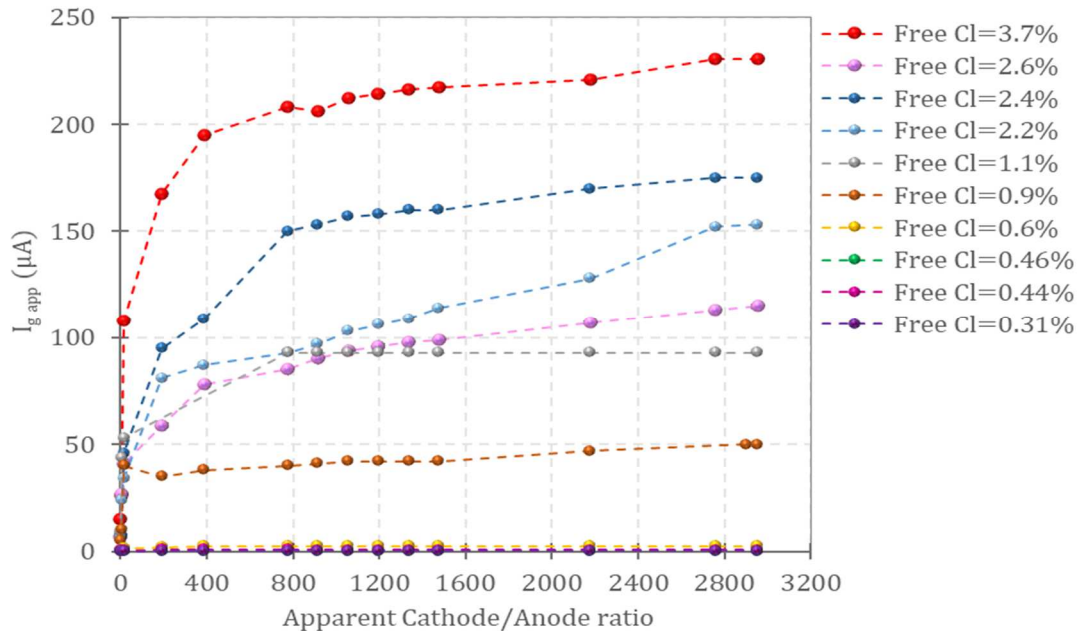

Fig. 20. Results of the experimental C/A ratio test

593 The effective C/A ratios were also estimated and reached very high values (almost 200000).
594 Yet, the influence of the effective ratio on corrosion current was found the same to that obtained when
595 dealing with the apparent ratios.
596

597 In the next part, the results obtained with both apparent C/A ratios 16 and 2950 will be
598 presented according to the different free chloride contents. This will allow to determine the threshold
599 galvanic current which will be the criteria for the determination of the chloride threshold value in case
600 of a formulation formed with an ordinary Portland cement.
601

602 6. Chloride threshold values based on a chloride threshold current

603 Fig. 21 presents the corrosion currents exchanged between anode and cathode for different
604 free chloride contents for the apparent C/A ratios of 16 and 2950 in case of ARS specimens.

605 The concept of initiation of corrosion is set according to a limit current. This implies that the initiation
606 criteria is related to a certain limiting galvanic current that is independent of the area of passive steel.
607 This threshold current must then be independent of the C/A ratio.

608 The limiting current was found equal to 3 μA . For galvanic currents lower than 3 μA , all the obtained
609 currents are almost the same independently from the C/A ratio. On the other hand, for galvanic
610 currents higher than 3 μA , the galvanic currents obtained with a ratio of 2950 are 3 times bigger than
611 the ones obtained with a C/A ratio equal to 16.

612 Consequently, the total and free chloride threshold values for CEMI in the case of ARS, CSPT
613 and CSPH specimens are respectively 0.6 and 0.5 %/wt. cement. However, in the case of cleaned steel,
614 the free Cl content is 1.9%/wt. cement corresponding to a total chloride content of 2%/wt. cement.

615 Indeed, in Fig. 12, the galvanic corrosion current was a linear function of chloride content, with
616 a slope change of around 0.5% of free chlorides by weight of cement in case of ARS, CSPT and CSPH
617 specimens and 1.9%/wt. cement in case of CS specimens. The chlorides threshold values are in
618 agreement with the discussion made earlier about the influence of the steel type condition on corrosion
619 (part 4).

620 Using this approach, it would be possible to compare different types of binders, which would
621 constitute a further step in the research.

622

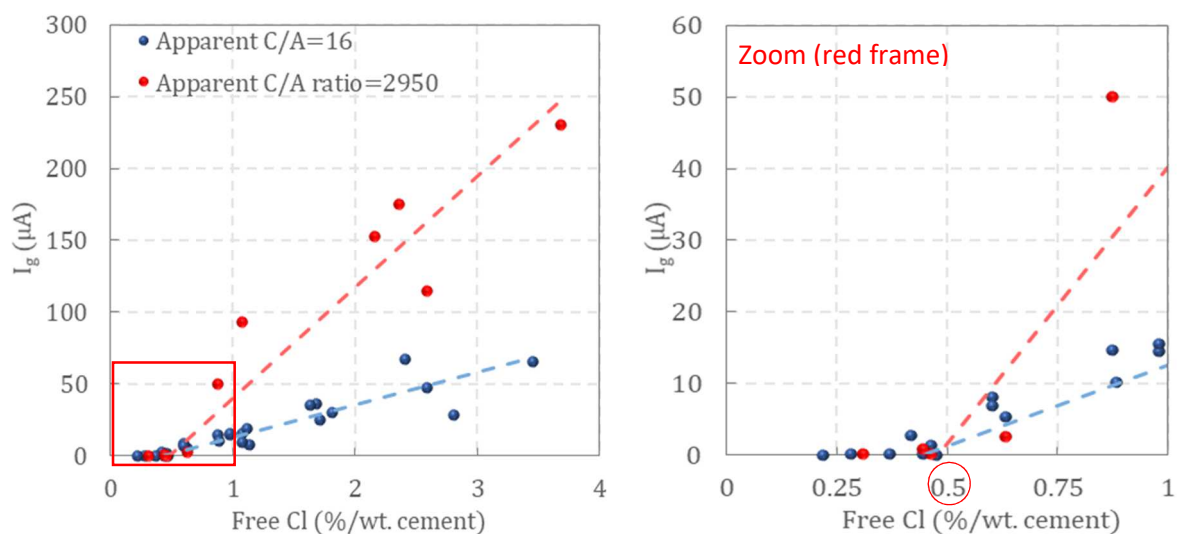

Fig. 21. I_g measured for different free chloride contents for apparent C/A ratios of 16 and 2950.

623

624 7. Conclusion

625 This paper has presented a new test set-up established on the localized aspect of chloride-
626 induced corrosion in reinforced concrete structures. This two-piece system first allows the galvanic
627 corrosion current between anodic (with chlorides) and cathodic (without chlorides) zones to be
628 measured, which was impossible to do in tests performed on single bar specimens.

629 The first results presented in this paper are limited to CEM I samples. These preliminary results
630 highlight the influence of chloride content and steel surface on the corrosion rate. It was deduced that
631 an increase in chloride levels led to an increase in the number of "corroded sites", leading to an increase
632 in the galvanic currents measured. The role of mill scale on corrosion kinetics was also highlighted when
633 comparing results obtained with 4 different steel types. The similarity of behaviour between as received
634 steel, ARS, and cleaned pre-oxidized steel, CSP, may be attributed to the resemblance in the
635 composition of the mill scale layer found on the ARS and the layer of corrosion products formed on CSP.
636 The non-uniformity of these layers may justify the presence of some irregular current densities
637 obtained. The corrosion kinetics obtained in the absence of mill scale (cleaned steel specimens) were
638 relatively weak. This phenomenon may be attributable to a less porous passive film making it harder
639 for the chloride ions to diffuse through.

640 With this test, it is possible to determine the chloride threshold values initiating corrosion and
641 also the corrosion current during the propagation stage. The criteria for corrosion initiation was set as
642 a limiting galvanic current called threshold corrosion current. This current is defined as a current that

643 is independent of the cathode/anode surface ratio and was found equal to 3 μA . This indicates that the
644 corrosion initiation must be linked to a threshold current that is not affected by surface ratio between
645 cathode and anode. The total and free chloride threshold values for CEMI in case of ARS, CSPT and CSPH
646 specimens are respectively 0.6 and 0.5 %/wt. cement. However, in case of cleaned steel, the free Cl
647 content is 1.9%/wt. cement corresponding to a total chloride content of 2%/wt. cement.

648 Furthermore, it was confirmed that an increase in the C/A ratio led to an increase in the galvanic
649 current, which is in agreement with the fundamental galvanic coupling concepts. The experimental
650 results also showed that the current growth rate decreased with increasing cathodic surface area,
651 which could mean that the current would reach its maximum value and stabilize for a given C/A ratio.

652 With this method, it is also possible to compare different types of binders which will be the next
653 step of the study.

654

655 Acknowledgements

656 This work was supported by the ANR MODEVIE project, grant ANR-14-CE22-0018 of the French
657 Agence Nationale de la Recherche and by the French National Federation of Public Works (FNTP).

658

659 References

- 660 [1] U. Angst, B. Elsener, C. K. Larsen and Ø. Vennesland, *Critical chloride content in reinforced*
661 *concrete — A review*, Cement and Concrete Research, 39 (2009), pp. 1122–1138.
- 662 [2] M. Stern and A.L. Geary, *Electrochemical Polarization I. A Theoretical Analysis of the Shape of*
663 *Polarization Curves*, Vol. 104, 1957.
- 664 [3] C. Andrade, C. Alonso, J. Gulikers, R. Polder, R. Cigna, Ø. Vennesland et al., *Test Methods for On-*
665 *Site Corrosion Rate Measurement of Steel Reinforcement in Concrete by Means of the Polarization*
666 *Resistance Method*, Vol. 37, 2004.
- 667 [4] A. Clément, S. Laurens, G. Arliguie and F. Deby, *Numerical Study of the Linear Polarisation*
668 *Resistance Technique Applied to Reinforced Concrete for Corrosion Assessment*, Vol. 16, 2012.
- 669 [5] C. Wagner and W. Traud, *Über die Deutung von Korrosionsvorgängen durch Überlagerung von*
670 *elektrochemischen Teilvorgängen und über die Potentialbildung an Mischelektroden*, Zeitschrift
671 für Elektrochemie und angewandte physikalische Chemie 44 (1938), pp. 391–402.
- 672 [6] A. Sagues and S. C. Kranc, *On The Determination of Polarization Diagrams of Reinforcing Steel in*
673 *Concrete*, Vol. 48, 1992.
- 674 [7] J. Gulikers, *Numerical Simulation of Corrosion Rate Determination by Linear Polarization*, 2015.
- 675 [8] S. Laurens, P. Hénocq, N. Rouleau, F. Deby, E. Samson, J. Marchand et al., *Steady-state*
676 *polarization response of chloride-induced macrocell corrosion systems in steel reinforced concrete*
677 *— numerical and experimental investigations*, Cement and Concrete Research 79 (2016), pp.
678 272–290.
- 679 [9] B. Elsener, *Macrocell Corrosion of Steel in Concrete - Implications for Corrosion Monitoring*, Vol.
680 24, 2002.
- 681 [10] U. Angst and M. Büchler, *On the Applicability of the Stern–Geary Relationship to Determine*
682 *Instantaneous Corrosion Rates in Macro-Cell Corrosion*, Vol. 66, 2014.
- 683 [11] R. Francois, S. Laurens and F. Deby, *Corrosion and Its Consequences for Reinforced Concrete*
684 *Structures*, Elsevier, 2018.
- 685 [12] B. Elsener, C. Andrade, J. Gulikers, R. Polder and M. Raupach, *Half-Cell Potential Measurements –*
686 *Potential Mapping on Reinforced Concrete Structures*, Vol. 36, 2003.
- 687 [13] R. Francois, G. Arliguie and D. Bardy, *Electrode Potential Measurements of Concrete*
688 *Reinforcement for Corrosion Evaluation*, Vol. 24, 1994.

- 689 [14] G01 Committee, *Test Method for Corrosion Potentials of Uncoated Reinforcing Steel in Concrete*,
690 ASTM International, .
- 691 [15] L. Tang, J.M. Frederiksen, U. Angst, R. Polder, M. Cruz Alonso, B. Elsener et al., *Experiences from*
692 *RILEM TC 235-CTC in Recommending a Test Method for Chloride Threshold Values in Concrete*,
693 Vol. 3, 2018.
- 694 [16] U. Angst, C. Boschmann, M. Wagner and B. Elsener, *Experimental Protocol to Determine the*
695 *Chloride Threshold Value for Corrosion in Samples Taken from Reinforced Concrete Structures*,
696 2017.
- 697 [17] J. Pacheco and R. Polder, *Critical Chloride Concentrations in Reinforced Concrete Specimens with*
698 *Ordinary Portland and Blast Furnace Slag Cement*, Vol. 61, 2016.
- 699 [18] P. V. Nygaard and M. Geiker, *A Method for Measuring the Chloride Threshold Level Required to*
700 *Initiate Reinforcement Corrosion in Concrete*, Vol. 38, 2005.
- 701 [19] V. Garcia, R. Francois, M. Carcasses and P. Gegout, *Potential Measurement to Determine the*
702 *Chloride Threshold Concentration That Initiates Corrosion of Reinforcing Steel Bar in Slag*
703 *Concretes*, Vol. 47, 2014.
- 704 [20] P. Sandberg, *Chloride initiated reinforcement corrosion in marine concrete*, Division of Building
705 Materials, LTH, Lund University, 1998.
- 706 [21] U. Angst, B. Elsener, C. Larsen and Ø. Vennesland, *Chloride Induced Reinforcement Corrosion:*
707 *Electrochemical Monitoring of Initiation Stage and Chloride Threshold Values*, Vol. 53, 2011.
- 708 [22] N. R. Jarrah, O. Al-Amoudi, M. Maslehuddin, O. A. Ashiru and A. Ibrahim Al-Mana, *Electrochemical*
709 *Behaviour of Steel in Plain and Blended Cement Concretes in Sulphate and/or Chloride*
710 *Environments*, Vol. 9, 1995.
- 711 [23] V. Bouteiller, C. Cremona, V. Baroghel-Bouny and A. Maloula, *Corrosion Initiation of Reinforced*
712 *Concretes Based on Portland or GGBS Cements: Chloride Contents and Electrochemical*
713 *Characterizations versus Time*, Vol. 42, 2012.
- 714 [24] *ISO 8407:2009(en), Corrosion of metals and alloys — Removal of corrosion products from*
715 *corrosion test specimens*.
- 716 [25] *NF EN 14629 - Produits et systèmes pour la protection et la réparation des structures en béton -*
717 *Méthodes d'essais - Mesurage du taux de chlorure d'un béton durci*. 2007.
- 718 [26] H. Hornain, *GrandDuBé: grandeurs associées à la durabilité des bétons*, Presses des Ponts, 2007.
- 719 [27] P. Ghods, O. Isgor, G. A. McRae, J. Li and G.P. Gu, *Microscopic investigation of mill scale and its*
720 *proposed effect on the variability of chloride-induced depassivation of carbon steel rebar*, *Corr.*
721 *Sci.* 53 (2011), pp. 946–954.
- 722 [28] E. Mahallati and M. Saremi, *An Assessment on the Mill Scale Effects on the Electrochemical*
723 *Characteristics of Steel Bars in Concrete under DC-Polarization*, Vol. 36, 2006.
- 724 [29] A. T. Horne, I. G. Richardson and R. M. D. Brydson, *Quantitative Analysis of the Microstructure of*
725 *Interfaces in Steel Reinforced Concrete*, Vol. 37, 2007.
- 726 [30] D. Neff, S. Réguer, L. Bellot-Gurlet, P. Dillmann and R. Bertholon, *Structural Characterisation of*
727 *Corrosion Products on Archaeological Iron: An Integrated Analytical Approach to Establish*
728 *Corrosion Forms*, Vol. 35, 2004.
- 729 [31] D. L. a. de Faria, S. Venâncio Silva and M. T. de Oliveira, *Raman Microspectroscopy of Some Iron*
730 *Oxides and Oxyhydroxides*, Vol. 28, 1997.
- 731 [32] S. Réguer, D. Neff, L. Bellot-Gurlet and P. Dillmann, *Deterioration of Iron Archaeological Artefacts:*
732 *Micro-Raman Investigation on Cl-Containing Corrosion Products*, Vol. 38, 2007.
- 733 [33] D. Neff, P. Dillmann, L. Bellot-Gurlet and G. Beranger, *Corrosion of Iron Archaeological Artefacts in*
734 *Soil: Characterisation of the Corrosion System*, Vol. 47, 2005.
- 735 [34] M. Hanesch, *Raman Spectroscopy of Iron Oxides and (Oxy)Hydroxides at Low Laser Power and*
736 *Possible Applications in Environmental Magnetic Studies*, Vol. 177, 2009.

737 [35] J. Warkus and M. Raupach, *Modelling of reinforcement corrosion – geometrical effects on*
738 *macrocell corrosion*, *Materials and Corrosion* 61 (2009), .
739