



HAL
open science

Insights into the local interaction mechanisms between fermenting broken maize and various binder materials for anaerobic digester structures

Marie Giroudon, Cédric Perez, Matthieu Peyre Lavigne, Benjamin Erable, Christine Lors, Cédric Patapy, Alexandra Bertron

► To cite this version:

Marie Giroudon, Cédric Perez, Matthieu Peyre Lavigne, Benjamin Erable, Christine Lors, et al.. Insights into the local interaction mechanisms between fermenting broken maize and various binder materials for anaerobic digester structures. *Journal of Environmental Management*, 2021, 300, 10.1016/j.jenvman.2021.113735 . hal-03342050

HAL Id: hal-03342050

<https://insa-toulouse.hal.science/hal-03342050v1>

Submitted on 13 Sep 2021

HAL is a multi-disciplinary open access archive for the deposit and dissemination of scientific research documents, whether they are published or not. The documents may come from teaching and research institutions in France or abroad, or from public or private research centers.

L'archive ouverte pluridisciplinaire **HAL**, est destinée au dépôt et à la diffusion de documents scientifiques de niveau recherche, publiés ou non, émanant des établissements d'enseignement et de recherche français ou étrangers, des laboratoires publics ou privés.

1 **Insights into the local interaction mechanisms between fermenting broken** 2 **maize and various binder materials for anaerobic digester structures**

3 Marie Giroudon^{1,2}, Cédric Perez^{3,4,5}, Matthieu Peyre Lavigne², Benjamin Erable³, Christine Lors^{4,5},
4 Cédric Patapy¹, Alexandra Bertron^{1*}

5 1. LMDC, Université de Toulouse, UPS, INSA Toulouse, France

6 2. TBI, Université de Toulouse, CNRS, INRA, INSA, Toulouse, France

7 3. Laboratoire de Génie Chimique, Université de Toulouse, CNRS, INPT, UPS, Toulouse,
8 France

9 4. IMT Lille Douai, Institut Mines Télécom, Univ. Lille, Centre for Materials and Processes, F-
10 59000 Lille, France

11 5. Univ. Lille, Institut Mines Télécom, Univ. Artois, Junia, ULR 4515 - LGCgE, Laboratoire de
12 Génie Civil et géo-Environnement, F-59000 Lille, France

13 * Corresponding author: bertron@insa-toulouse.fr

14 **Highlights**

- 15 • Cement matrices face biodeterioration but have little effect on anaerobic digestion
- 16 • CH₄ production was similar in all BMP reactors (with/without binder materials)
- 17 • Alkali-activated metakaolin shows a thinner chemically modified layer
- 18 • Metakaolin paste impacts the digestion in terms of [NH₄⁺], biomass nature, and pH
- 19 • The sessile and planktonic microbial communities are different

20 **Abstract**

21 Concrete structures of anaerobic digestion plants face chemically aggressive conditions due to the
22 contact with the complex liquid fraction of the fermenting biowaste. This paper aims to determine
23 the biogeochemical dynamic interaction phenomena at play between the biowaste and cementitious
24 matrices at the local scale, and to identify durable binders in such environments. Binder materials

25 likely to show increased durability – slag and calcium aluminate cement, and a metakaolin-based
 26 alkali-activated geopolymer – and a reference Portland cement were inserted into sealed bioactors
 27 during 5 cycles (245 days) of broken maize anaerobic digestion. Cementitious pastes suffered
 28 chemical and mineralogical alteration related mainly to carbonation and leaching. However, they had
 29 no negative impact on the bioprocess in terms of pH, metabolic evolution of volatile fatty acids and
 30 NH_4^+ , planktonic microbial community composition or CH_4 production. In all reactors, the microbial
 31 community was able to perform the anaerobic digestion successfully. The MKAA was only slightly
 32 altered in its outermost layer. Its presence in the biowaste induced lower NH_4^+ concentrations, a
 33 slightly higher pH and a marked shift in the microbial community, but CH_4 total production was not
 34 affected. Substantial enrichment of acid forming bacteria, especially members of the genus
 35 *Clostridium*, was observed in the biofilm formed on all materials.

36 Keywords: Anaerobic digestion, cementitious materials, geopolymer, durability, biodeterioration,
 37 biofilm

38 Graphical abstract

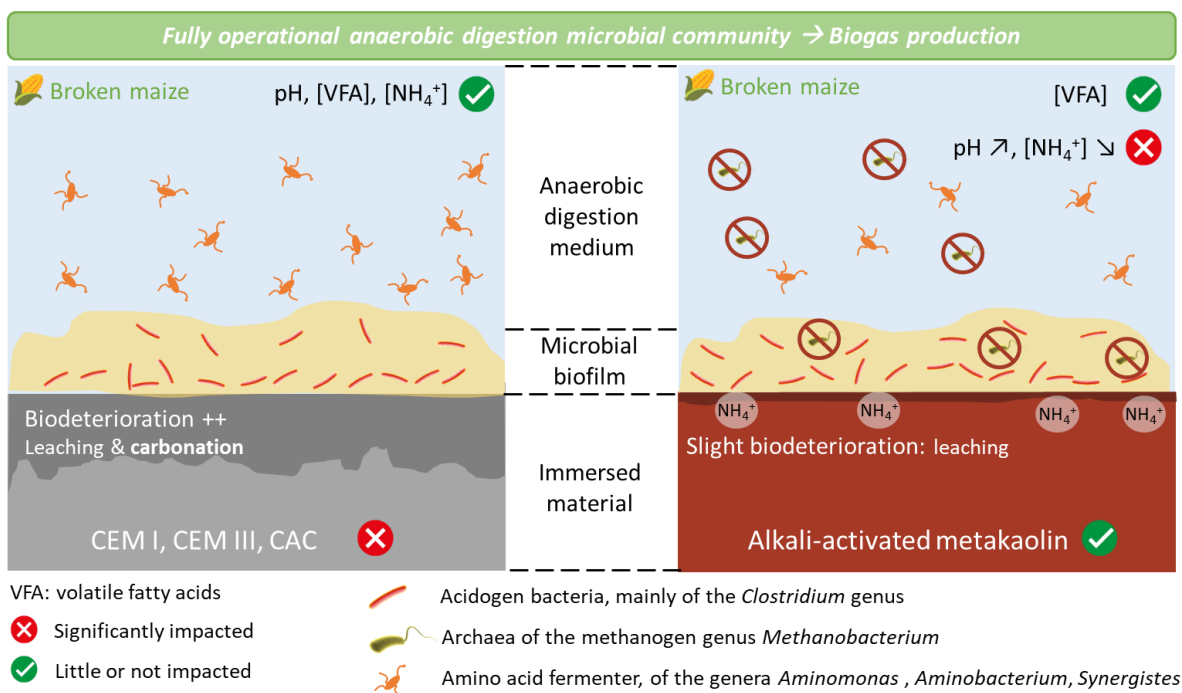

39

40 **1 Introduction**

41 Anaerobic digestion (AD) is the process of transforming organic matter into a methane (CH₄)-rich gas
42 (the biogas) and a moist conditioner and fertilizer (the digestate) by anaerobic microorganisms. In
43 the current context of sustainable transition towards low carbon renewable energies and reduction
44 of greenhouse gas emissions into the atmosphere, the development of the sector is being
45 encouraged in Europe and the number of industrial installations is growing. As an illustration, in
46 France, the objective of the Pluriannual Energy Programme is to reach the target of including 7 % to
47 10 % of biogas in the total gas consumption by 2030 (Ministère de la transition écologique et
48 solidaire, 2020).

49 On an industrial scale, the AD bioprocess is implemented in anaerobic digesters, i.e. fermentation
50 plants, which are mainly made of concrete because this material is economical, easy to implement,
51 waterproof, and has a good thermal inertia. While the upper part of the structure, in contact with
52 the biogas, is often protected from the aggressiveness of the environment by liners (Nathalie
53 Bachmann, 2013), in the lower part, the concrete is in direct contact with the biowaste undergoing
54 digestion. Concrete structures that are thus directly exposed to the fermenting biowaste experience
55 severe deterioration (Giroudon et al., 2021a; Koenig and Dehn, 2016; Perez et al., 2021; Voegel et al.,
56 2019, 2016) which could affect the sustainability of the structures and their durability, with both
57 economic and environmental consequences.

58 In more detail, the microbiologically driven AD bioprocess requires the succession of four steps of
59 biowaste degradation under anaerobic conditions: hydrolysis, acidogenesis, acetogenesis and
60 methanogenesis (Batstone et al., 2002; Evans and Furlong, 2003). During the first step,
61 macromolecules of biowaste are broken into smaller molecules. These compounds of lower
62 molecular weight are then fermented by acidogenic bacteria during the second step, leading to the
63 specific production of volatile fatty acids (VFA) (mainly propionic, acetic and butyric acids). During the
64 following step of acetogenesis, the products of the previous step are converted into acetate, H₂ and

65 CO₂ (Bond and Templeton, 2011). Finally, CO₂ and CH₄ are produced through two distinct pathways
66 during methanogenesis: the hydrogenotrophic pathway produces CH₄ from H₂ and CO₂; and the
67 acetoclastic pathway uses acetate as a precursor substrate (Kratat et al., 2010). All the AD reaction
68 steps are carried out by microorganisms that can adopt clustered structures in the form of sludge,
69 aggregates, or biofilms, which allow close interaction and cooperation between the microbial
70 populations involved in the four reaction stages. Some of the microbial metabolites produced in the
71 AD process, especially VFA, dissolved CO₂, and NH₄⁺ ions (contained directly in some waste and/or
72 produced along with VFA during acidogenesis (Meegoda et al., 2018)) are known to be aggressive for
73 concrete (Giroudon et al., 2021a; Koenig and Dehn, 2016; Perez et al., 2021; Voegel et al., 2019) and
74 are present in varying proportions. Moreover, the action of microorganisms organised in biofilms on
75 the concrete surface can increase the local concentration of metabolites and locally accentuate the
76 aggressiveness of the environment and thus the degradation of the concrete (Magniont et al., 2011).

77 With a view to enhancing the durability of concrete in this expanding industrial sector, this study
78 aims at an extensive understanding of the biogeochemical interactions between cement matrices
79 and the liquid fraction of biowaste in AD. On the one hand, the impact of the presence of different
80 binder materials on the performance of the AD bioprocess is evaluated considering (i) the CH₄
81 production, (ii) the chemical composition of the liquid fraction in terms of VFA concentrations, NH₄⁺
82 ion concentration and pH, and (iii) the microbial diversity of sessile and planktonic biomasses. On the
83 other hand, the chemical and mineralogical changes of the binder materials previously exposed to
84 the fermenting biowaste are also assessed. Cement pastes made of blast-furnace slag cement (CEM
85 III), calcium aluminate cement (CAC), a metakaolin-based alkali-activated geopolymer (MKAA) likely
86 to show increased durability in this medium (Bertron et al., 2007a; Drugă et al., 2018; Duan et al.,
87 2015; Grengg et al., 2020; Gruyaert et al., 2012; Oueslati and Duchesne, 2012; Singh et al., 2015) and
88 an ordinary Portland cement (CEM I) were immersed for 245 days in airtight biochemical methane
89 potential (BMP) reactors (Holliger et al., 2016) inoculated with broken maize. This substrate was
90 selected because it offers a high methanogenic potential (Bruni et al., 2010; Gerin et al., 2008) and

91 also because it allows the microbial production of a large amount of organic acids during the
 92 acidogenesis step, generating aggressive chemical conditions for the cement matrices. A high
 93 solid/liquid ratio (surface area of the material sample/liquid volume) was used in order to reproduce
 94 the local conditions occurring in the vicinity of the digester concrete walls.

95 2 Materials and methods

96 The experimental protocol was similar to the one developed and validated by Giroudon et al. (2021a)
 97 and is presented in Figure 1.

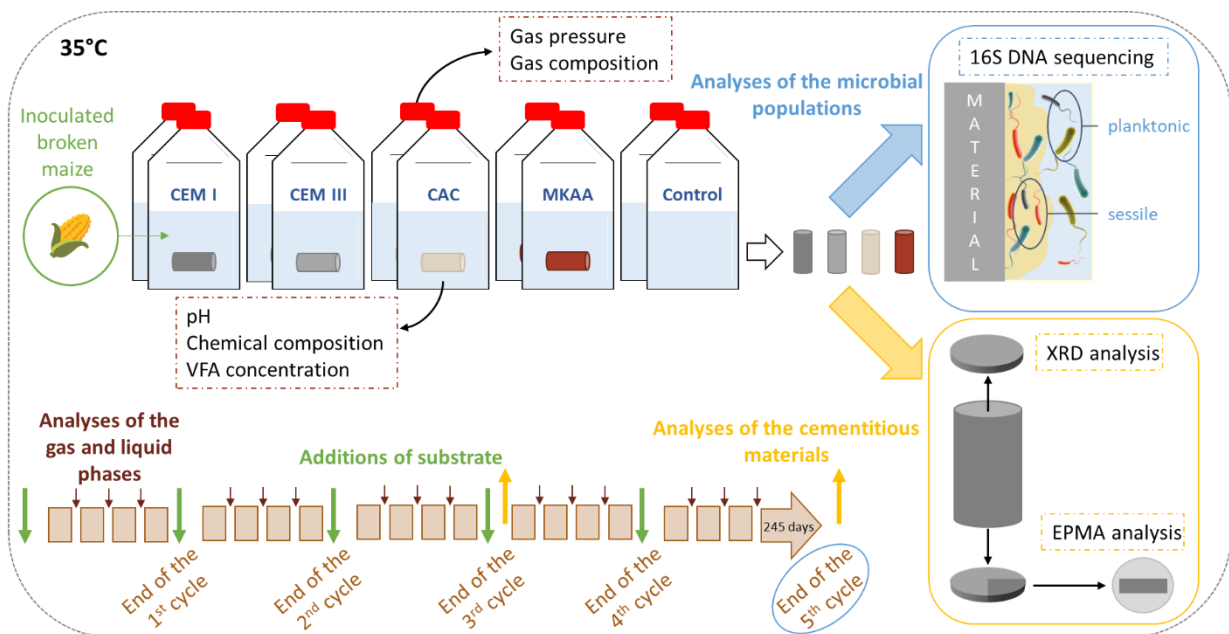

98

99 *Figure 1: Schematic representation of the experimental protocol describing the samples, the experiments, and the temporal*
 100 *management of the solid, liquid and microbial fraction analyses, adapted from Giroudon et al. (2021a)*

101 It consisted of immersing pastes made of ordinary Portland cement CEM I 52.5R (CEM I), CEM III/B
 102 42.5N (CEM III), calcium aluminate cement, Calcoat[®] RG (CAC), and a metakaolin-based alkali-
 103 activated (MKAA) paste, in reactors inoculated with broken maize at 35 °C, in order to reproduce
 104 anaerobic digestion during 5 cycles of digestion.

105

106 **2.1 Binders**

107 The cement pastes (CEM I, CEM III, CAC), called cementitious materials or cement pastes below, were
108 poured with a water/binder ratio of 0.30. The MKAA geopolymer was made according to the
109 procedure of Pouhet (2015) by using metakaolin, liquid sodium silicate (molar ratio $\frac{SiO_2}{Na_2O} = 1.7$) and
110 water. Geopolymers are aluminosilicate materials formed by the activation of an aluminosilicate
111 source, such as metakaolin, by a strongly basic alkaline solution (Pouhet et al., 2019).

112 The samples were made according to the procedure described in the study by Giroudon et al.
113 (2021a), i.e., the paste specimens were mixed using the French standard NF EN 196-1 (2016) and cast
114 in cylindrical moulds 75 mm high and 25 mm in diameter. They were cured in sealed plastic bags and
115 were then exposed to the biowaste in AD.

116 The water porosities of the pastes were measured according to the NF P18-459 standard (AFNOR,
117 2010). The measurements show a significantly higher porosity of the MKAA paste (48.6 %) and a
118 lower porosity of the CAC paste (24.0 %) in comparison with the CEM I and CEM III pastes, whose
119 water porosity values were intermediate - about 32.0 % and 35.6 %, respectively.

120

121 **2.2 Immersion of cement pastes in laboratory BMP reactors**

122 The protocol of immersion consisted of immersing cement paste specimens in airtight BMP reactors
123 (Holliger et al., 2016) containing 80 mL of microbial inoculum from an industrial biogas plant located
124 in Haute-Garonne (France) and broken maize from a farm in Barcelonne-du-Gers (Gers, France) as
125 the biowaste. For each kind of material, the experiment was carried out in duplicate with two BMP
126 reactors each containing a sample. In addition, two control BMP reactors without material were also
127 operated and monitored over the same period of time. The detailed protocol is presented in
128 Giroudon et al. (2021a) (Section 2.1).

129 The mass of added broken maize increased with the cycles of AD (Table 1), in order to increase the
130 aggressiveness of the medium with time. Each cycle of AD was considered complete when the gas

131 production in the BMP reactors stopped (Table 1). During the third cycle, once the biogas production
 132 was complete, the BMP reactors were kept at room temperature for 5.5 weeks because
 133 the laboratory closed for the summer break.

134 *Table 1: Mass of broken maize added per cycle and duration of each cycle*

	1 st cycle	2 nd cycle	3 th cycle		4 th cycle	5 th cycle
Temperature	35°C	35°C	35°C	Room	35°C	35°C
Mass of broken maize added (g)	3	3	4		5	5
Duration of a cycle (weeks)	10	4.5	5	5.5	5	5

135

136 **2.3 Analyses of liquid and gas fractions**

137 Several times a week, the BMP reactors were shaken manually, the gas pressure was measured with
 138 a manometer, and gas and liquid were sampled using syringes. Gas samples were analysed using gas
 139 chromatography (GC Trace 1300 Thermofisher, Mobile phase Helium, Separation Column Hayssep N
 140 60-80 1.0 m x 1/16, oven temperature 110°C, detector TCD) (O₂-N₂, H₂, CH₄, CO₂ and H₂S). pH was
 141 immediately measured in the liquid samples before they were centrifuged for 5 min (Eppendorf,
 142 Centrifuge 5430R, 4 °C, RCF 7197) and the supernatant was filtered through a 0.2 µm filter for further
 143 analysis. The NH₄⁺ concentration was analysed by ion chromatography (Dionex Thermofisher
 144 ICS2000, Guard column AG19, IonPac CS12 3x250 mm, at 30 °C with eluent generator cartridge EGC
 145 III MSA for methanesulfonic acid) and the concentrations of some VFA (acetic, propionic, butyric,
 146 isobutyric, valeric, and isovaleric acids) were analysed by gas chromatography (Varian 3900/430,
 147 WAX column: length 15 m, external diameter 0.53 mm, thickness of the internal phase 1 µm,
 148 detector FID). In addition, gas and liquid compositions were used to calculate the aqueous inorganic
 149 CO₂ concentration in the liquid fraction using Henry's law considering a temperature of 35 °C and
 150 atmospheric pressure (values of the Henry's law constants from Batstone et al. (2002)).

151 **2.4 Analyses of the changes in binder materials**

152 The binder materials were removed from the BMP reactors after the 3rd and the 5th cycles and slices
 153 were sawn from their ends with a diamond saw. The remaining cylinders were re-immersed in the

154 BMP reactors as quickly as possible to continue the experiments, while the slices were used in
155 analyses of the mineralogical and chemical changes following exposure to the fermenting biowaste.
156 The mineralogical degradation in depth was assessed by qualitative X-Ray Diffraction (XRD) (Brucker
157 Avance, Co cathode, 40 kV, 40 nA) by successively analysing and abrading the plane side of the slice
158 until the core of the material was reached (initial mineralogical composition) (Bertron et al., 2005a).
159 The chemical composition was quantitatively characterized by Electron Probe Micro-Analysis (EPMA)
160 (Cameca XFive, 15 kV, 20 nA) on polished sections: series of chemical punctual analyses (Ca, Si, Al, Fe,
161 Mg, P and S) were performed from the surface in contact with the liquid fraction to the core of the
162 specimen, avoiding the anhydrous grains. Calibrations were performed on synthetic natural controls
163 before each run. The graphs are the combination of two chemical profiles in mass percentage of
164 oxides from the same sample (each chemical profile consisting of a series of punctual chemical
165 analyses, from the surface in contact with the biowaste to the sound core) and smoothed over 3
166 points for better readability, using a moving average (Bertron et al., 2009). Trend and smoothed
167 curves were then established from these graphs.

168 **2.5 Analysis of microbial populations**

169 The protocol for collecting sessile microbial communities was adapted from Perez et al. (2021) in
170 order to capture two distinct layers in the thickness of the biofilm successively. The "weakly adhered"
171 biofilm was removed from the cementitious material surface by an immersion in phosphate buffered
172 saline solution (PBS, 0.1 M, pH 7.4) for 15 minutes. The "strongly adhered" biofilm was removed by 3
173 minutes of sonication treatment (FB 15061 Fisher Scientific, ultrasonic frequency 37 Hz) in PBS. For
174 both treatments, the entire PBS volume containing the detached biomass was then recovered. A 2
175 mL sample was also collected from the liquid fraction of each BMP reactor (Figure 1).

176 DNA was extracted from the three types of samples ("weakly adhered" biomass, "strongly adhered"
177 biomass and planktonic biomass from the liquid fraction) with the Qiagen DNeasy power biofilm DNA
178 extraction kit, according to the protocol described by the manufacturer. The extracted DNA was sent
179 to RTL Genomics(Texas, USA), where the 16s rDNA was amplified using the 515F and 806R primers,

180 targeting both bacteria and archaea. Sequencing of the amplified DNA was also performed by RTL
 181 Genomics (USA) using a MiSeq Illumina platform (details of the amplification and sequencing
 182 protocols are available in the supplementary data). Data analysis for DNA quality, DNA sequence
 183 alignment, and clustering in operational taxonomic units and taxonomic assignment were also
 184 performed by RTL Genomics according to their protocol (available at
 185 <https://rtlgenomics.com/amplicon-bioinformatics-pipeline>). The sequencing raw sequence reads
 186 were published in the NCBI SRA database (accession: PRJNA758226; direct link:
 187 <https://www.ncbi.nlm.nih.gov/Traces/study/?acc=PRJNA758226>). The number of OTUs (Operational
 188 Taxonomic Units) identified at the taxonomic levels of species and genera were analysed statistically
 189 using the R software, (R Core Team, 2017). A heatmap was produced with the "Marray" package
 190 using Ward's classification method and the calculation of distance based on the correlation between
 191 the standardized abundance scores of each OTU. Principal component analyses (PCA) were
 192 performed with the "Factominer" and "Factoextra" packages.

193

194 3 Results

195 3.1 Characterization of the AD bioprocess with respect to the immersed binder

196 Table 2 gives the total production of CH₄ in each AD cycle for all BMP tests, with and without binder
 197 materials, and the cumulative total production at the end of the experiment.

198 *Table 2: Total production of CH₄ (NmL.g⁻¹ of broken maize) at the end of each digestion cycle and cumulative total*
 199 *production at the end of the experiment (Total). Results are expressed as mean value of the two duplicates of BMP reactors*
 200 *± the standard deviation.*

	Control BMP reactors	CEM I	CEM III	CAC	MKAA	Mean values per cycle
Production of CH ₄ (NmL.g ⁻¹ of broken maize)						
1 st cycle	1530 ± 232	1439 ± 13	1579 ± 67	1379 ± 252	1336 ± 145	1453 ± 101
2 nd cycle	1298 ± 88	1271 ± 91	1234 ± 48	1186 ± 136	1136 ± 131	1225 ± 65
3 rd cycle	1308 ± 82	1214 ± 23	1270 ± 5	1283 ± 32	1178 ± 123	1251 ± 53
4 th cycle	1005 ± 380	996 ± 290	1236 ± 81	1620 ± 556	1129 ± 39	1197 ± 256
5 th cycle	1011 ± 174	1102 ± 45	1124 ± 3	1247 ± 46	1222 ± 35	1141 ± 96
Total	6152 ± 100	6022 ± 144	6392 ± 3	6715 ± 175	6001 ± 395	6267 ± 306

201

202 Despite the presence of the binder materials, the production of CH₄ was similar in all the BMP
203 reactors during the whole experiment (Table 2). Even though the amount of broken maize biowaste
204 was increased between the first and the last cycle, there was a slight decrease in the amount of CH₄
205 produced, probably due to the evolution, during storage, of the biowaste, the methanogenic
206 potential of which decreased with time.

207 Figure 2 gives the evolution in time of the pH, the total concentration of VFA and the ammonium
208 concentration in the liquid fraction of the BMP reactors.

209 The production of the different VFA in the different BMP reactors as a function of time is available in
210 the supplementary materials (Appendix A). It shows that the production of acetic acid was
211 predominant, and that the production and consumption of the different VFA was simultaneous in
212 each type of BMP reactor.

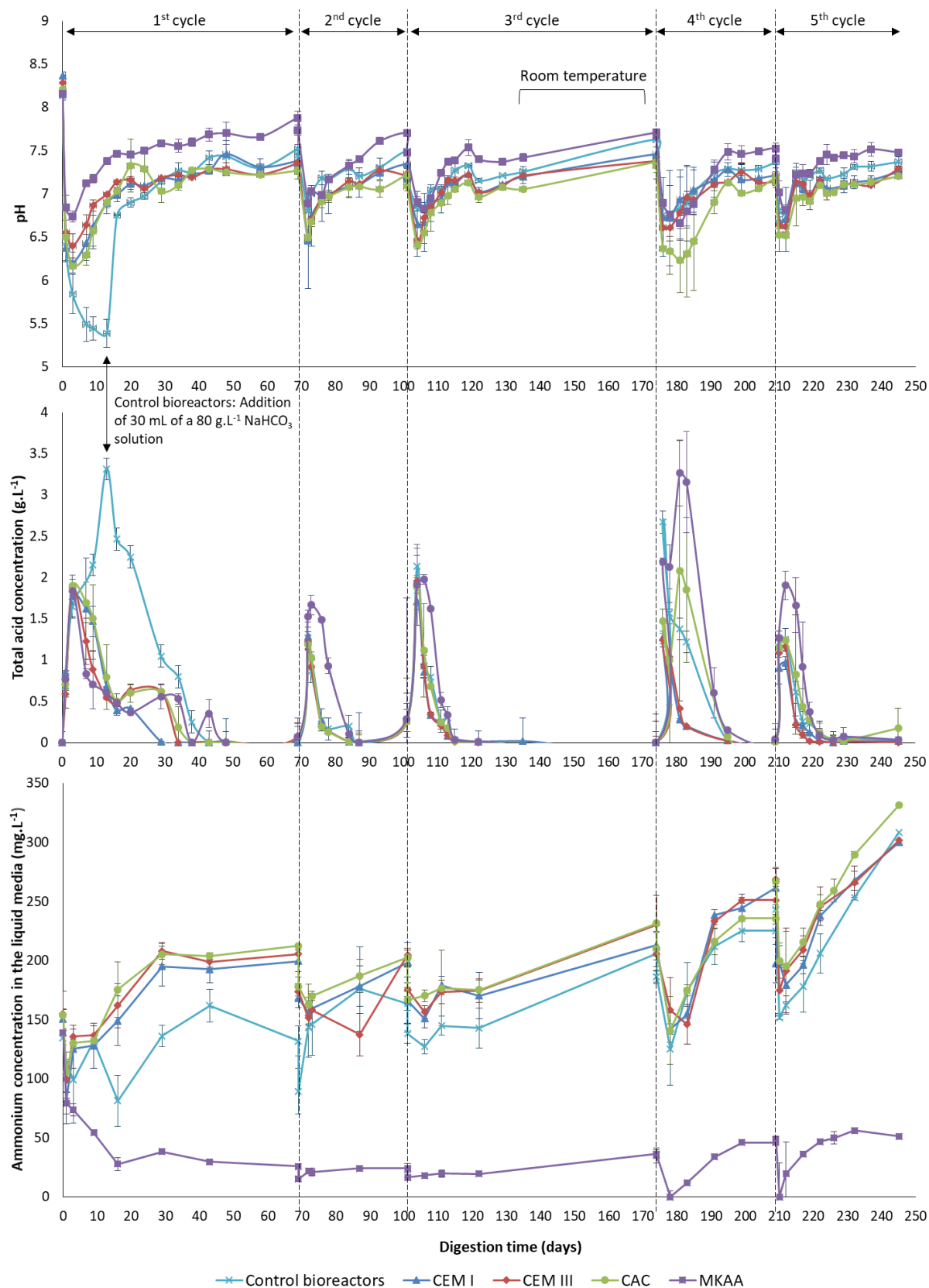

213

214 *Figure 2: Evolution of the pH, of the total VFA concentration and of the ammonium concentration during the five cycles of*
 215 *AD in the BMP reactors, with or without binder materials. Mean values of the two duplicate BMP reactors are presented*
 216 *with the standard deviations.*

217

218 At the beginning of the experiment (day 0), the pH values were very close in all the BMP reactors (8.2
219 ± 0.1). After three days, the pH had significantly decreased, reaching 5.8 ± 0.23 , 6.2 ± 0.12 , 6.4 ± 0.14 ,
220 6.2 ± 0.01 , and 6.7 ± 0.06 in the control BMP reactors and the BMP reactors containing CEM I, CEM
221 III, CAC and MKAA pastes, respectively. On the same day (day 3), the VFA concentration increased to
222 $1.8 \pm 0.1 \text{ g.L}^{-1}$. Thereafter, the VFA were consumed and the pH increased in the BMP reactors
223 containing the binder materials. In the meantime, the pH continued to decrease in the control BMP
224 reactors with no decrease of the acid concentration. Until day 13, the pH in these reactors continued
225 to drop and reached 5.4 ± 0.20 , with an extremely high total VFA concentration of $3.3 \pm 0.23 \text{ g.L}^{-1}$. In
226 order to avoid acidosis (acidic inhibition) in the BMP reactors, 30 mL of a NaHCO_3 solution (80 g.L^{-1})
227 was injected into each control reactor to increase the pH and promote favourable conditions for the
228 AD bioprocess. The natural rise in pH in the BMP reactors containing the binder materials was due to
229 the strong buffering effect of the cementitious and alkali-activated materials. The addition of the
230 NaHCO_3 solution in the control reactors led to an increase of the pH and therefore allowed
231 methanogenic microbial activity to take place (confirmed by the methane production rate measured,
232 data not shown), leading to the consumption of the VFA and to the production of biogas.

233 Subsequently, the variations in pH were typical of a fed-batch AD bioprocess: the pH was between
234 7.0 and 7.5 in the steady state (suitable for AD microbial populations) and a decrease in pH occurred
235 after each new addition of biowaste, due to the fast production of VFA. Starting from cycle 2, the
236 microbial communities in the control BMP reactors adapted to the AD of broken maize, and the pH
237 naturally rose after each addition of broken maize. The lower buffering effect of CAC material in
238 comparison with the other materials induced a slightly lower pH during the experiment, which may
239 have had an impact on the balance of microbial populations.

240 During the first cycle, among the BMP reactors containing binder materials, the pH was slightly
241 higher in those containing the MKAA (about +0.5) while the VFA concentrations were similar. The pH

242 in these reactors remained that much higher during the whole experiment. However, with the
243 increase of the biowaste load from 3 to 5 g, the presence of MKAA induced a higher VFA
244 concentration and a slower consumption of acids. This could reflect a poorer efficiency of the
245 methanogenesis step. All VFA were, however, consumed at the end of each cycle and in all BMP
246 reactors.

247 The presence of the cementitious materials CEM I, CEM III and CAC did not significantly influence the
248 NH_4^+ concentration in the liquid fraction compared to that in the control BMP reactors. At the
249 beginning of each cycle, the evolution of the NH_4^+ concentration resulted from two opposite effects:
250 the addition of water led to a decrease in the NH_4^+ concentration by dilution, whereas the addition of
251 biowaste generated a gradual increase in NH_4^+ concentration. This increase was much more
252 significant during cycles 4 and 5, probably because the biowaste load was increased from 4 to 5 g.
253 The NH_4^+ concentrations in the BMP reactors containing the cementitious materials and the controls
254 were of the order of 150 to 300 mg.L^{-1} during this experiment, which is much lower than the values
255 measured with bovine manure (approximately 750 mg.L^{-1} at the end of the first cycle) (Giroudon et
256 al., 2021a). As highlighted in the study by Giroudon et al. (2021a), the presence of MKAA induced
257 significantly lower NH_4^+ concentrations (between 0 and 50 mg.L^{-1}), probably due to the NH_4^+
258 adsorption capacity of this material.

259 In the control BMP reactors, the sodium concentration increased sharply between the start of the
260 first cycle ($64.7 \pm 2.7 \text{ mg.L}^{-1}$) and the start of the second cycle ($867.7 \pm 22.0 \text{ mg.L}^{-1}$) due to the
261 addition of the NaHCO_3 solution on the 13th day (Table 3). Subsequently, the sodium concentration
262 decreased slightly during the experiment, from 867.7 ± 22.0 to $721.3 \pm 13.2 \text{ mg.L}^{-1}$. This decrease was
263 the consequence of a dilution effect due to the addition of water at the beginning of each cycle, in
264 order to balance the volume losses related to liquid fraction sampling. Similar salinity values were
265 observed for the BMP reactors containing the CEM I, CEM III and CAC: the sodium concentrations
266 were between 74.0 ± 5.7 and $93.2 \pm 2.1 \text{ mg.L}^{-1}$. The MKAA BMP reactors showed the highest salinity

267 values (about 1500 mg.L⁻¹ of sodium in solution) because MKAA were activated with sodium silicate,
 268 and thus released a larger quantity of sodium.

269 *Table 3: Concentrations of Na⁺ and salinity ([Na⁺] + [K⁺] + [PO₄³⁻] + [Mg²⁺] + [Ca²⁺]) in the liquid fraction of the BMP reactors*
 270 *at the start of each cycle (after the addition of water and maize), with or without the binder materials. Results are expressed*
 271 *as mean value of the two duplicates of BMP reactors ± the standard deviation.*

		Start of the 1 st cycle	Start of the 2 nd cycle	Start of the 3 rd cycle	Start of the 4 th cycle	Start of the 5 th cycle
[Na ⁺] mg.L ⁻¹	Control	64.7 ± 2.7	867.7 ± 22.0	818.4 ± 4.8	763.1 ± 3.3	721.3 ± 13.2
	CEM I	74.0 ± 5.7	90.2 ± 8.7	90.5 ± 0.6	93.2 ± 2.1	86.1 ± 5.7
	CEM III	77.4 ± 6.3	86.9 ± 4.0	85.9 ± 0.9	87.1 ± 4.6	79.5 ± 0.8
	CAC	73.2 ± 2.8	89.4 ± 3.6	93.2 ± 2.2	89.6 ± 3.7	78.6 ± 2.2
	MKAA	100.1 ± 4.4	1431.1 ± 26.7	1533.4 ± 1.8	1554.7 ± 26.3	1519.3 ± 3.1
Salinity mg.L ⁻¹	Control	475.8 ± 13.4	1230.5 ± 314.9	1462.7 ± 91.5	1132.4 ± 31.2	1115.5 ± 34.5
	CEM I	537.1 ± 38.8	957.0 ± 35.5	1048.9 ± 32.4	848.1 ± 85.3	829.8 ± 147.7
	CEM III	572.1 ± 52.3	859.6 ± 37.5	936.7 ± 38.7	627.4 ± 14.6	523.0 ± 178.0
	CAC	520.4 ± 10.3	828.6 ± 30.3	904.8 ± 31.0	679.8 ± 33.4	699.6 ± 62.4
	MKAA	532.3 ± 32.3	1579.3 ± 57.8	1703.8 ± 14.8	1656.3 ± 31.4	1609.1 ± 7.8

272

273 3.2 Microbial composition of sessile and planktonic biomasses

274 The clustering by similarity shown on Figure 3 allows different groups and subgroups to be
 275 distinguished within the samples on the X axis and the OTUs grouped by genera on the Y axis. A
 276 grouping according to the type of material used in the BMP reactor was observed: the MKAA group is
 277 clustered on the right of the Figure 3 and all the other materials and the negative sample, without
 278 material, are mostly grouped on the left side of this figure. Subgroups formed in accordance with the
 279 origin of the microorganisms samplings. Groups of planktonic and sessile samples were clearly
 280 divided. Concerning the grouping of the identified OTUs, there were also groups and subgroups.
 281 However, no strong relation was observed between the groups of samples and the group of OTUs.
 282 This classification method does not highlight the relationships between the OTUs, the type of
 283 samples and the type of material used.

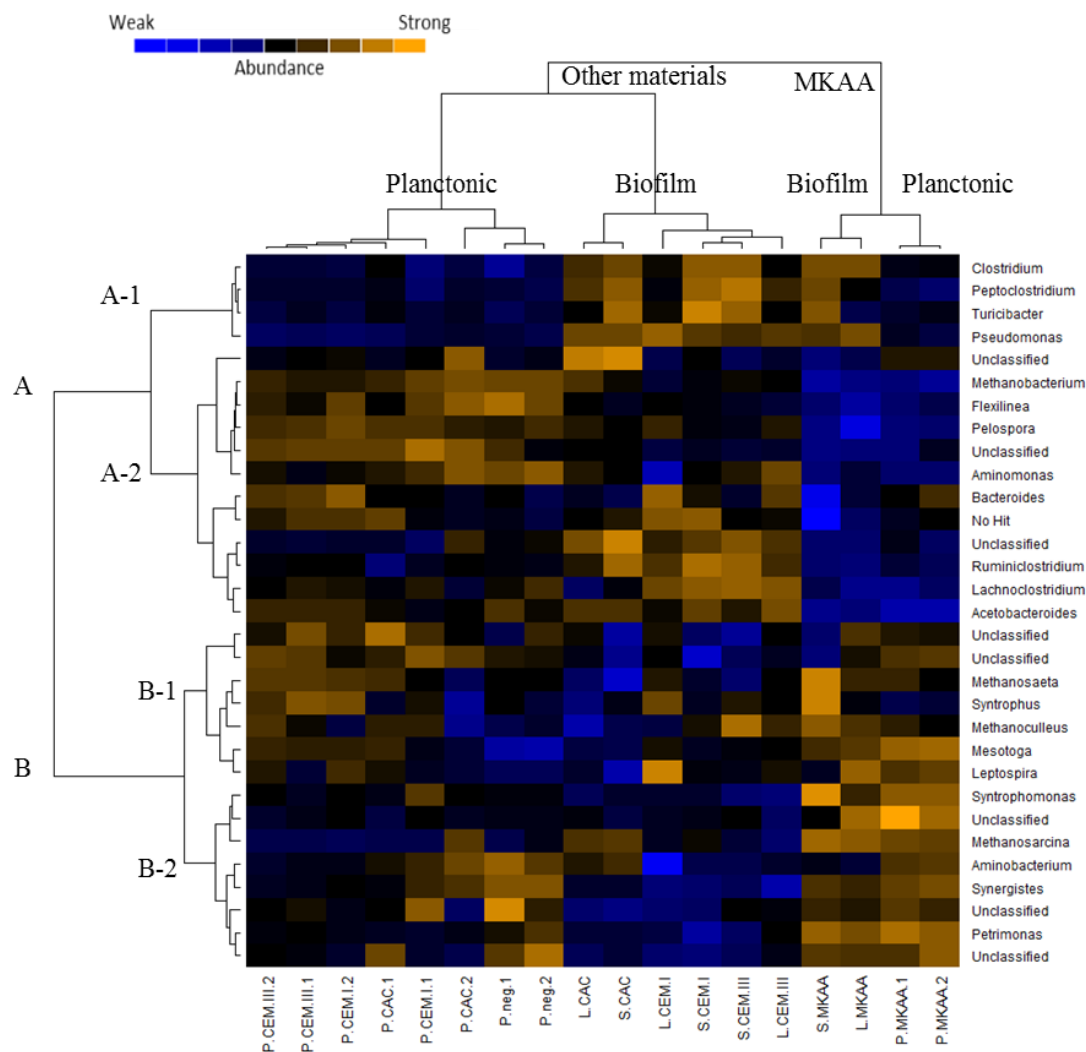

284

285 *Figure 3: Heatmap with colour scale of the next generation sequencing of the 16S DNA from planktonic biomass samples*
 286 *and "poorly" and "strongly" adhered biomass taken from the surface of cementitious material samples, and after 5 cycles of*
 287 *anaerobic digestion – L: weakly adhered biofilm; S: Strongly adhered biofilm; P: Planktonic; only OTU genera with an*
 288 *abundance of at least 1% in at least one sample are shown*

289 In order to assess these relationships, a principal component analysis (PCA) was carried out (Figure
 290 4). Microbial samples are categorized according to the binder material used and the origin of the
 291 samples. The samples found on the left side of dimension 1 axis of Figure 4 all belong to the BMP
 292 reactors where MKAA (in blue) was immersed, while all the other samples are grouped on the right
 293 side of dimension 1 axis. The first PC, which explains 33.7 % of the global variability, is thus linked to
 294 the presence/absence of MKAA.

295 The second PC, explaining 25.6 % of the variability, is correlated with the origin of samples, since the
 296 strongly adhered biofilm samples (squares) are on the bottom part of dimension 2 axis, the liquid

297 samples (circles) on the top part, and the weakly adhered biofilm samples (triangles) are situated
298 between these two groups. So, the second PC is highly correlated with the origin of the microbial
299 samples and samples positioned towards the top of the dimension 2 axis should be the microbial
300 populations that were situated the closest to the cementitious material surfaces. Also, the
301 populations from the weakly adhered biomass should include a mix between the microbial
302 populations of the other two groups.

303 Therefore, the data presented can mainly be categorised according to two main criteria, which are
304 affiliated with the two CPs highlighted in Figure 4: firstly, the location of the sample, i.e. liquid or
305 weakly/strongly attached biomass and, secondly, the material exposed, i.e. MKAA binder or all other
306 binder materials tested.

307 It is interesting to look at Figure 3 while looking for the specific OTU genera found in these groups.
308 Several microbial genera appear more likely to be detected in the MKAA samples. These are the
309 acetogen genera *Petrimonas* and *Syntrophomonas* (T. E. Board, 2015; Sekiguchi, 2015). As for the
310 samples without MKAA: the genera *Methanobacterium* (methanogen), *Pelospora*, *Bacteroides*,
311 *Ruminoclostridium*, *Lachnoclostridium*, *Aminomonas*, *Flexilinea* (acidogens) and *Acetobacteroides*
312 (acetogen) are more abundant in those samples (Baena et al., 2015; Schink, 2015; Su et al., 2014;
313 Turlousse and Sekiguchi, 2018; Venkiteshwaran et al., 2015).

314 When considering the other main criteria categorising our data, some kinds of OTUs were found
315 more predominantly in the biofilm samples. These genera, identified as *Clostridium*,
316 *Peptoclostridium*, *Pseudomonas* and *Turicibacter* (acidogen) (Bosshard, 2015), are the members of
317 the A-1 group (Figure 3). The *Pseudomonas* genus mainly contains CO₂-producing respiring bacteria,
318 known for their ability to form biofilms (Yoon et al., 2002). Also, among these four cited genera, the
319 acidogen genera *Clostridium*, *Peptoclostridium* and *Turicibacter* were more abundant in the strongly
320 adhered biofilm than in the loosely adhered one. As for the genera associated with the planktonic

321 lifestyle, the *Aminobacterium* genus and the *Synergistes* genus are both amino acid fermenters (E.
322 Board, 2015).

323 The same clustering by similarities, initially presented at the genus level in Figure 3, was also
324 performed at the level of the microbial species. The results are available as supplementary data
325 (Appendix B). This clustering based on comparison at the microbial species level resulted in findings
326 almost identical to those already shown in Figure 3. The genus *Clostridium* was highly represented,
327 14 OTUs being identified as belonging to this specific bacterial genus. The presence of each of these
328 OTUs was significantly higher in the biofilm samples regardless of the type of binder material. This
329 confirms the predisposition of this genus to widely form biofilms on surface materials. Among the
330 methanogenic population, 4 genera were identified: *Methanobacterium*, *Methanosarcina*,
331 *Methanoculleus* and *Methanosaeta*. *Methanosarcina*, *Methanoculleus* and *Methanosaeta* were
332 present in all the microbial samples in both the planktonic and biofilm samples. However, the
333 hydrogenotrophic methanogens, represented by the *Methanobacterium* genus, were almost absent
334 in the MKAA samples. The amino acid fermenter genera, *Synergistes*, *Aminobacterium* and
335 *Aminomonas*, leading to the release of NH_4^+ ions, were more often detected in the liquid fraction
336 than in the biofilm.

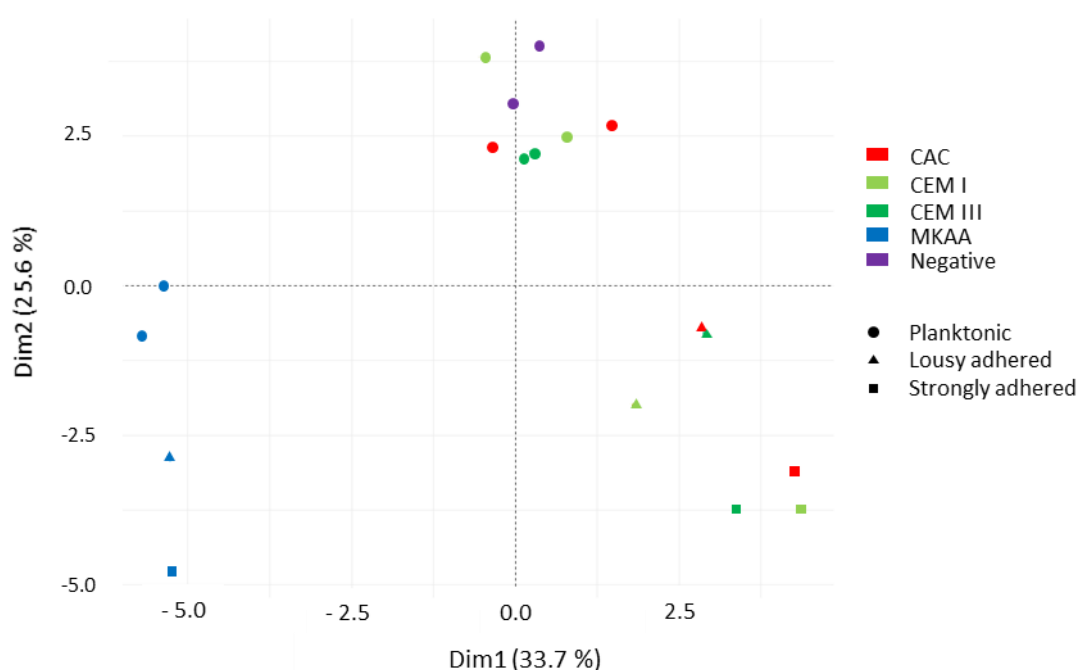

337

338 *Figure 4: PCA of microbial communities found in anaerobic digestion biomass samples and representation according to*
339 *either the type of material or the location of the biomass sample – Distribution of all the samples according to the two main*
340 *Principal Components (PC)*

341

342

343 **3.3 Chemical and mineralogical changes in the binder materials**

344 The mineralogical and chemical changes of CAC pastes after 3 and 5 cycles of immersion in the
345 fermenting broken maize are available in the Supplementary materials (Appendix C) since the effect
346 of biodeterioration only marginally modified this material throughout the experiment. The
347 mechanisms explaining these moderate mineralogical and chemical evolutions under AD conditions
348 have already been described in detail in the work of Voegel et al.(2019).

349 For better readability, the results for the CEM I, CEM III and MKAA are presented in the form of trend
350 graphs. Original data (CEM I and CEM III after 5 cycles of AD) are provided as Supplementary
351 materials (Appendix D, Appendix E, Appendix F and Appendix G).

352 *3.3.1 CEM I*

353 Figure 5 shows the chemical and mineralogical features of CEM I pastes resulting from 3 and 5 cycles
354 of immersion in the fermenting broken maize. The measurements were carried out respectively by
355 EPMA and XRD, as a function of the distance to the surface of the CEM I paste in contact with the
356 fermenting biowaste. The EPMA analysis highlighted three main zones after 3 cycles and 4 main
357 zones after the 5th cycle. The sound paste was mainly made of calcium (50 %) and silicon (17 %) with
358 minor amounts of aluminium, sulfur and iron. The mineralogical analyses showed the presence of
359 typical hydrated (portlandite, ettringite) and anhydrous (C_2S , C_3S , brownmillerite, C_3A) crystallized
360 phases of a Portland cement-based hydrated matrix. The material mainly underwent decalcification
361 with a progressive decrease in the CaO content together with some dissolution (decrease of the

362 silicon and aluminium contents and dissolution of the Ca-bearing phases, mainly CH¹) associated with
 363 the carbonation of the outer layer of the CEM I paste (zones 3 and 2) with the precipitation of calcite
 364 and vaterite. Additionally, an enrichment in exogenous phosphorus, probably supplied by the
 365 fermenting biowaste, was spotted in the external zone. After 3 and 5 cycles, the sound zone was
 366 identified at about 600 μm deep. The main difference between these two limits was the presence of
 367 an intermediate zone spotted after 5 cycles (zone 3), between 100 and 300 μm deep, where calcium
 368 and silicon contents remained stable while the sulfur content fell to 0 %.

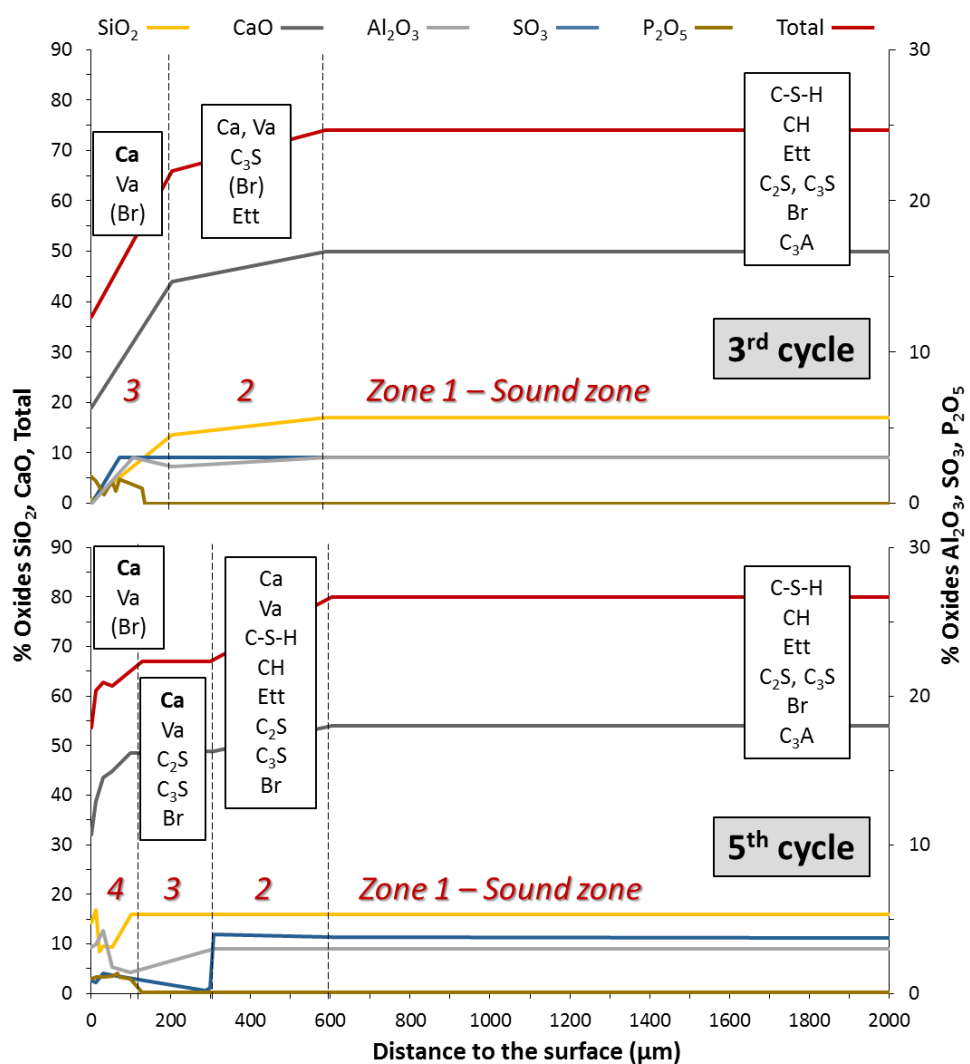

369

370 Figure 5: Schematic representation of chemical composition of oxides and mineralogical composition (analysed by EPMA
 371 and XRD, respectively) of the CEM I pastes after 3 and 5 cycles of exposure to fermenting broken maize – Ett: ettringite; Ca:

¹ Cement chemistry shorthand notations: A = Al₂O₃, C = CaO, F = Fe₂O₃, H = H₂O, M = MgO, S = SiO₂

372 *calcite; Va: vaterite; Br: brownmillerite – Bold characters = intensification of the XRD signal in comparison with the deeper*
373 *zone; Parentheses = significantly lower intensity of the XRD signal in comparison with the main phase*

374 3.3.2 CEM III

375 The sound CEM III paste was mainly made of calcium, silicon and aluminium with lower amounts of
376 sulfur and magnesium (Figure 6). The mineralogical analyses showed the same main crystalline
377 phases as for the CEM I paste. After 3 cycles, an enrichment in calcium was observed between 400
378 μm and 1200 μm , together with a slight enrichment in sulfur, even though no mineralogical changes
379 were observed. The decalcification of the paste stopped at about 400 μm deep, and the sulfur
380 content dropped to a value close to 0 % (zone 3). The decrease of all the oxide contents (zone 4) and
381 the phosphorus enrichment (zone 5) were observed in the external zones. The mineralogical analyses
382 showed the carbonation of the CEM III paste with the presence of calcium carbonates calcite and
383 vaterite.

384 After 5 cycles, an enrichment in sulfur was observed between 600 and 1200 μm deep, together with
385 the decalcification of the cement matrix (zone 4). Between 270 and 600 μm (zone 3), the calcium
386 content increased, probably due to the carbonation of the paste, whereas the total oxide content, as
387 well as the aluminium and the silicon contents, decreased. Once again, an intermediate zone (zone 2)
388 was marked by the stagnation of the calcium, aluminium and silicon contents whereas the sulfur
389 content dropped to 0 %, this time with an enrichment in phosphorus. The external zone showed
390 drops in the major oxide contents whereas a new enrichment in phosphorus was seen (zone 1). The
391 main crystalline phases were calcite and vaterite. For both limits, the modified depths of the CEM III
392 paste were significantly higher than for the CEM I paste (1200 μm vs. 600 μm respectively).

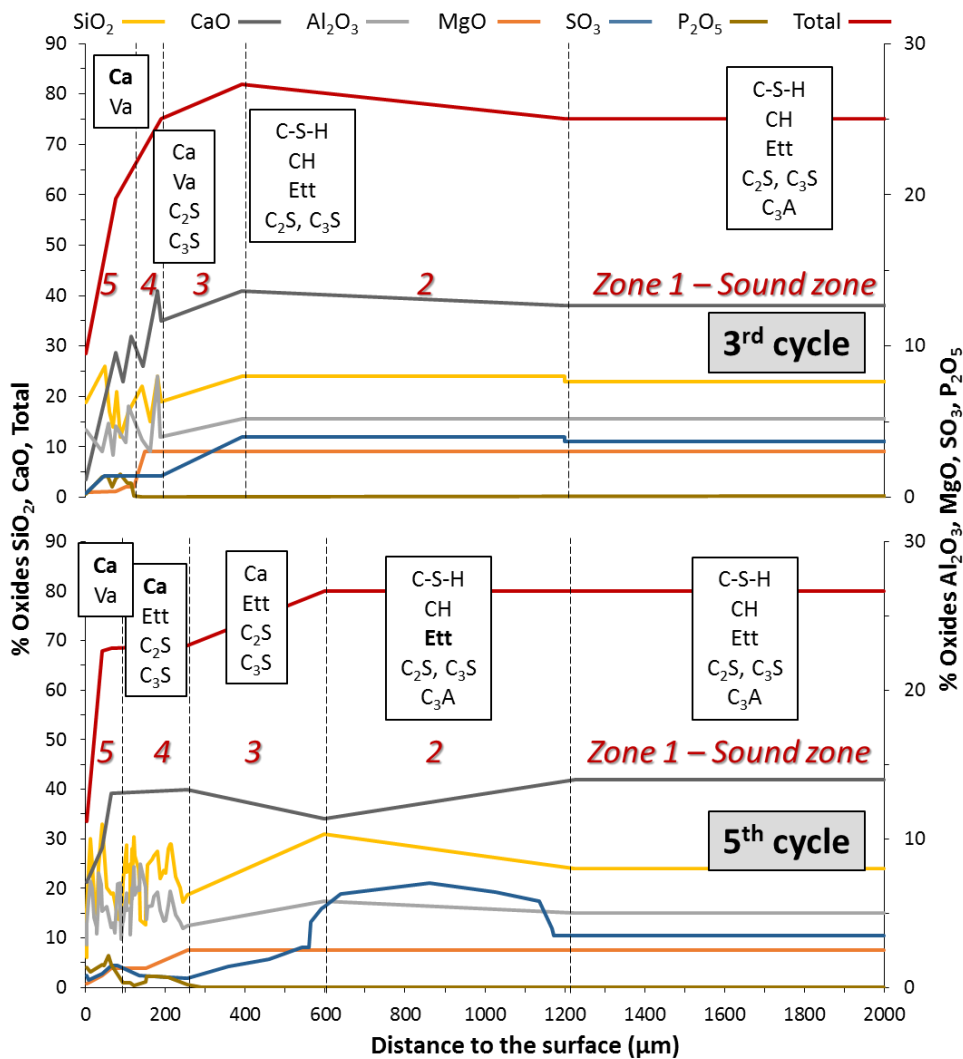

393

394 Figure 6: Schematic representation of chemical composition of oxides and mineralogical composition (analysed by EPMA
 395 and XRD, respectively) of the CEM III pastes after 3 and 5 cycles of exposure to fermenting broken maize– Ett: ettringite; Ca:
 396 calcite; Va: vaterite; Br: brownmillerite – Bold characters = intensification of the XRD signal in comparison with the deeper
 397 zone

398 3.3.3 MKAA

399 Figure 7 shows the chemical composition profiles of the MKAA paste together with the mineralogical
 400 phases identified. Because of the amorphous nature of the metakaolin and associated products of
 401 reaction, the XRD analyses did not show any mineralogical changes between the sound zone and the
 402 external part exposed to the aggressive environment. Only a thin outer fringe (100 and 180 µm wide
 403 respectively after the 3rd and 5th cycles) was significantly chemically modified, probably due to the
 404 dissolution of the paste. A drop in the potassium content was observed only in the degraded outer
 405 zone, around the outer 100 µm. Zone 1 bis showed the increase in the phosphorus content. After the

406 third cycle, this also corresponded to the increase in the sodium content just before its decrease in
 407 the outer zone, corresponding to its release into the liquid fraction. For the MKAA, it seems that the
 408 sodium contents in the solid varied greatly according to the depth, and the trends also varied
 409 depending on the samples. However, the decrease in the sodium content, like that of potassium,
 410 occurred only in the last micrometres (about 100 μm).

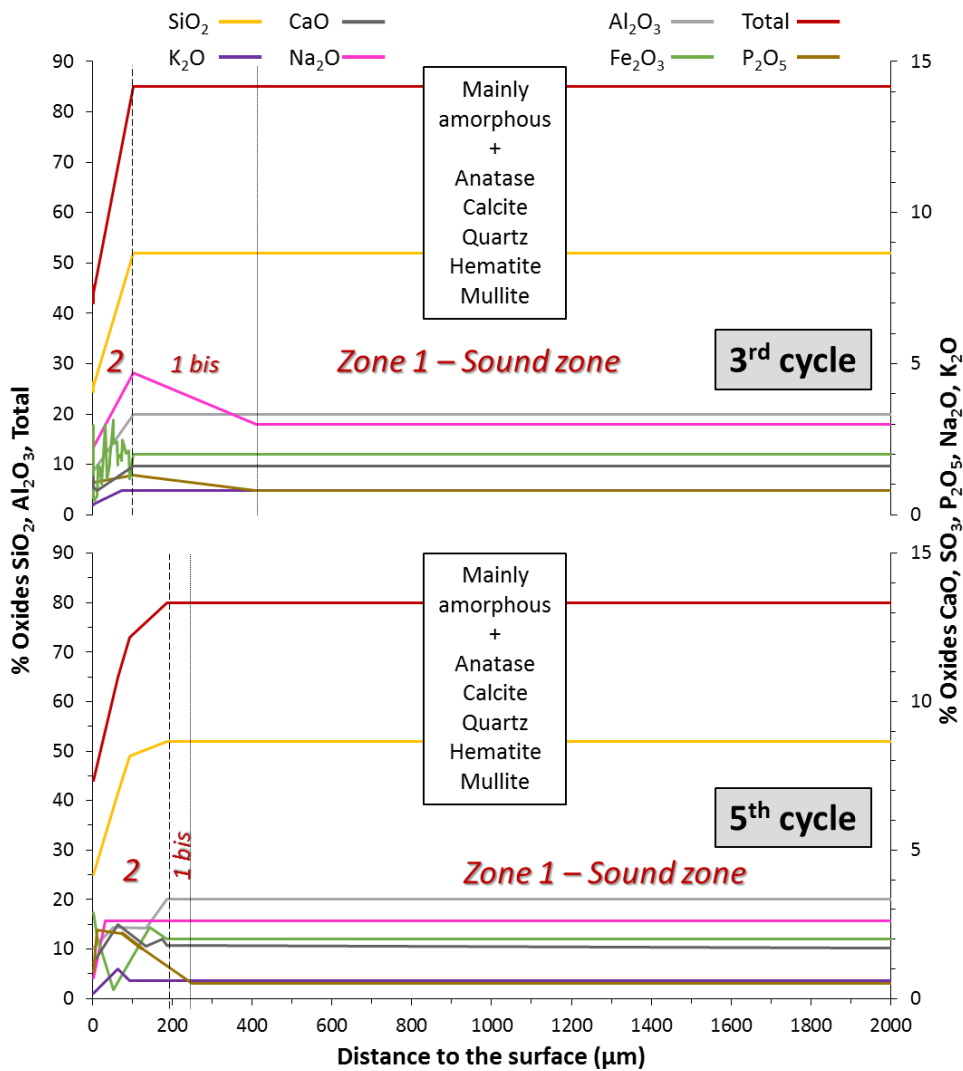

411

412 *Figure 7: Schematic representation of chemical composition of oxides and mineralogical composition (analysed by EPMA*
 413 *and XRD, respectively) of the MKAA pastes after 3 and 5 cycles of exposure to fermenting broken maize*

414

415 3.3.4 *Relative performances of the binders*

416 During the experiment (5 AD cycles, 245 days of exposition), the CEM I and CEM III pastes showed
417 greater chemical and mineralogical changes than the MKAA pastes, in particular linked to the
418 decalcification of the cement matrix and the dissolution of the initial mineralogical phases. In
419 addition, the modified depths of the CEM III paste were much greater than in other materials at the
420 end of the experiment. The MKAA samples appeared to show very stable behaviour against
421 biochemical attack, with a very shallow modified depth. Thus, a trend of chemical stability of
422 mineralogical phases to attack by digesting biowaste can be established on the basis of the results of
423 this study: CEM III < CEM I < MKAA.

424

425 **4 Discussion**

426 **4.1 Effect of the AD bioprocess on the binder materials**

427 Cementitious materials are porous and strongly basic reactive media that experience a chemical
428 attack by the liquid fraction of the biowaste in AD, thus releasing chemical compounds that could
429 disrupt microbial activities. In this study, despite the high solid/liquid ratio used, it was observed that
430 the presence of the binder materials did not decrease the efficiency of the AD, the CH₄ production
431 being similar in all BMP reactors.

432 These observations are different from what had been observed by Giroudon et al. (2021a) who, in a
433 slightly different way, studied the impact of cementitious materials on the AD of cattle manure.
434 However, they are consistent with the studies of Voegel et al. (2016, 2019b), where the authors
435 focused on the AD of collective food catering waste in laboratory conditions. With or without the
436 presence of cementitious materials, they described similar values and trends for the pH and for the
437 production kinetics of VFA, even though the CH₄ production was not measured. Broken maize has a
438 much greater methanogenic potential than cattle manure (French Chamber of Agriculture, 2010)
439 and, above all, faster hydrolysis. Thus, much higher VFA concentrations were observed at the start of

440 the cycles (maximum of 0.35 g.L⁻¹ for cattle manure and 1.8 g.L⁻¹ for broken maize in the first cycle),
441 linked to a strong acidification of the environment, as in the studies by Voegel et al. (2016, 2019b).
442 The transformation of this large amount of fermentable biowaste led to a production of CH₄
443 approximately 7.5 times greater than that obtained with cattle manure (data not shown).

444 For both biowastes (cattle manure and broken maize), the presence of the binder materials impacted
445 the AD bioprocess. In the case of AD of cattle manure, the alkalis of the materials (Na⁺, K⁺), released
446 during the first cycle, raised the pH and inhibited some of microorganisms implicated in the AD
447 bioprocess (acidogenic, acetogenic, and methanogenic populations). In the case of AD of broken
448 maize, the leaching of these alkalis counterbalanced the strong acidity of the liquid fraction, thus
449 avoiding the phenomenon of acidosis that appeared in the control BMP reactors during the first
450 cycle, and enabling the AD sequence to progress well.

451 In AD, NH₄⁺ is classically produced by the degradation of proteins or urea (Kayhanian 1999; Yenigün
452 and Demirel 2013), which justifies the high concentrations of NH₄⁺ during the AD of cattle manure
453 (approximately 750 mg.L⁻¹) (Giroudon et al., 2021a), while the concentrations did not exceed 350
454 mg.L⁻¹ with the broken maize. According to the pKa of the acid and conjugate base NH₄⁺/NH₃, i.e.
455 9.25, the ammonia was mainly in the form of NH₄⁺ ions in this experiment, with no possible stripping
456 in the gas phase. These low concentrations of NH₄⁺ are below the concentrations known to
457 inhibit/impact the microbial digestion activity, since the lowest inhibition values collected from the
458 literature are of the order of 600 mg.L⁻¹ (Karthikeyan and Visvanathan, 2013).

459 In both experiments (broken maize vs. cattle manure), in pH conditions suitable for AD, the presence
460 of MKAA led to a significant decrease in the concentration of NH₄⁺ ions. The hypotheses and possible
461 mechanisms between NH₄⁺ ions and the MKAA are detailed in Giroudon et al. (2021b).

462 **4.2 Microbial communities associated with binder materials**

463 *4.2.1 Microbial communities with sessile and planktonic lifestyles*

464 In our study, a strong presence of the *Clostridium* genus was found in the biofilm and even more in
465 the strongly adhered fraction of the biofilm, i.e. the layers closest to the solid material surface. A
466 similar finding has already been documented for a microbial biofilm formed on cellulose particles
467 during the anaerobic digestion of the particles in a batch process of particulate cellulose AD.
468 Hydrolytic bacteria colonized the particles during the first 14 days, then their number decreased to
469 be ultimately supplanted by methanogenic archaea (Song et al., 2005). In our study, the
470 methanogenic OTUs were present in both sessile and planktonic communities. Our samples were
471 exposed for almost 2.5 times as long as those of Perez et al. (2021), who recently compared the
472 microbial diversity of microbial communities collected from a fermenting biowaste, inoculated early
473 with activated sludge, and on CEM I cement pastes immersed in the same fermenting biowaste for
474 up to 15 weeks at 37 °C. They found that acidogenic bacterial populations were enriched in the
475 community colonizing the CEM I surface, especially members of the *Clostridium* genus. In the liquid
476 fraction, methanogens and acetogens were predominant. The longer exposure time of binder
477 materials in our study probably offered both planktonic and sessile communities the possibility to
478 mix and form a thicker, hierarchically organized biofilm on binder surfaces, explaining why, in our
479 case, methanogenic and acetogenic populations were present in the biofilm.

480 The presence of the genus *Clostridium* in the strongly adherent layers of the biofilm might be
481 interpreted as being due to its rapid implantation occurring very early in the cycle of biofilm
482 formation on the surface of the binders. Following its installation on the surface of the solid pastes,
483 its acidogenic metabolism would then lower the pH on the binder surface and make the pH
484 conditions more suitable for the integration of both methanogenic and acetogenic microorganisms in
485 the biofilm community. Consequently, this scenario is particularly detrimental to the cementitious

486 material, as the high local production of microbial acids on the surface would promote the acid
487 attack of the binder matrices and significantly increase the biodeterioration kinetics.

488 4.2.2 *Material influence on the microbial communities*

489 For all samples, regardless of the type of material, the microbial community identified corresponded
490 to a community capable of performing the four steps of anaerobic digestion and is commonly found
491 in anaerobic digestion environments (Venkiteshwaran et al., 2015).

492 A previous work immersing CAC, CEM I and CEM III cement pastes in a lab scale AD bioprocess
493 system showed a short-term inhibition of the microbial colonization of CAC material that
494 disappeared after 10 weeks (Voegel et al., 2020). In the present study, no significant difference
495 between CAC samples and CEM I, CEM III and planktonic samples was observed. This tends to
496 confirm that there is no inhibition caused by the CAC, for exposure times longer than 10 weeks
497 (Voegel et al., 2020).

498 The specific change in the microbial community in relation to the presence of the MKAA material is
499 most probably related to the lower NH_4^+ concentration observed in the reactors containing MKAA
500 material. This drop in NH_4^+ concentration is the only environmental variable that differs when the AD
501 batches with MKAA or with the other binder materials are compared. Sodium concentration was also
502 different when the AD bioprocess evolution with MKAA and with the other materials were
503 compared. But the values were really close to the concentration measured in the control. Although
504 NH_4^+ is a very common inhibitor of the AD bioprocess at concentrations above 600 mg.L^{-1}
505 (Karthikeyan and Visvanathan, 2013), the effects of low NH_4^+ concentrations on AD microbial
506 communities are not documented in the literature. It is therefore not entirely possible at this stage to
507 state with absolute conviction that NH_4^+ is responsible for this marked shift in the microbial
508 community. A dedicated comparative study involving dynamic monitoring of an anaerobic digestion
509 microbial community exposed to low or high concentrations of NH_4^+ could help to confirm the key
510 role of NH_4^+ . Nevertheless, CH_4 production was approximately the same in all BMP reactors,

511 indicating that, although the material had an influence on the microbial populations, it did not affect
512 the main function of anaerobic digestion.

513 **4.3 Deterioration mechanisms of the material samples**

514 *4.3.1 CEM I and CEM III*

515 Both CEM I and CEM III pastes showed mechanisms corresponding to a combination of leaching and
516 carbonation, with a phosphorus enrichment in the external zone, as identified in other studies
517 evaluating deterioration mechanisms of cementitious materials by biowaste in anaerobic digestion
518 (Bertron et al., 2017; Giroudon et al., 2021a; Voegel et al., 2019, 2016). However, unlike the pastes
519 immersed in inoculated cattle manure (Giroudon et al., 2021a), the CEM I and CEM III samples did
520 not show identical degradation mechanisms, since particular chemical changes were observed on the
521 CEM III pastes. Contrary to the findings of Koenig and Dehn's study (2016), where the use of low-
522 clinker binders with blast-furnace slag in the liquid fraction of a pilot scale fermenter led to a
523 reduction in depths of modification, the modified depths of the CEM III paste were twice those of
524 CEM I.

525 The CEM I paste showed deterioration mechanisms similar to the ones encountered for acids with
526 soluble salts and for NH_4^+ attacks, with a decalcification and gradual dissolution of the initial
527 mineralogical phases (Bertron et al., 2004; Bertron and Duchesne, 2013; Duchesne and Bertron,
528 2013; Escadeillas, 2013). However, despite the high concentrations of VFA (maximum VFA
529 concentrations between 1 and 3 g.L^{-1} at the beginning of the cycles), it appears that carbonation
530 played an important role in the chemical and mineralogical changes of the paste. Calcium carbonates
531 were detected in the outer layers, and the degraded depth did not increase as the experiment
532 progressed. This could be explained by the clogging of the cementitious matrix by calcium carbonates
533 (Baroghel-Bouny et al., 2008; Shah et al., 2018), leading to a slowing of the ingress of aggressive
534 agents'.

535 Carbonation phenomena are linked to the microbial production of CO₂ in the liquid fraction of the
536 fermenting biowaste. Dissolved CO₂ reacts with calcium released by the dissolution of cementitious
537 matrix phases to form calcium carbonates. However, the analyses of the liquid fraction of the
538 fermenting broken maize showed concentrations of total inorganic carbon similar to or even lower
539 than those reported by Giroudon et al.(2021a), with values of about 1000 mg.L⁻¹. At the equilibrium,
540 for the experiment with broken maize, the total inorganic carbon concentrations in the liquid fraction
541 were lower due to a lower concentration of CO₂ in the gas phase and a lower pH in the liquid
542 fraction. However, the quantity of CH₄ produced in the course of the experiment was significantly
543 higher in the case of the broken maize. Thus, even for lower observed concentrations of CO₂, its
544 microbial production was actually much higher during the digestion of the broken maize, which
545 induced a much greater flow of CO₂ in the liquid fraction in contact with the materials. This, in turn,
546 could explain the predominant effect of carbonation in this environment. This was confirmed by
547 experiments performed with chemical metabolites alone (Giroudon et al., 2021b) where the authors
548 immersed Ordinary Portland Cement pastes in single-compound-based solutions.

549 Carbonation phenomena were also identified in the CEM III paste, but the modified depth increased
550 significantly with time. The differences of behaviour between the CEM I and the CEM III pastes could
551 be linked to the initial greater porosity of the CEM III paste or to the poorer performance of slag
552 cements toward carbonation (Osborne, 1999).

553 In Portland based cements, portlandite is an abundant constituent of the paste and is the hydration
554 product that reacts the most readily with carbon dioxide (Galan et al., 2015; Thiery et al., 2007). Its
555 carbonation results in the precipitation of calcium carbonates in the pore network, decreasing the
556 total pore volume and shifting the pore size distribution curve toward smaller pore diameters (Šavija
557 and Luković, 2016). Moreover, the carbonation in Portland cement also causes a loss of pore
558 connectivity (Han et al., 2015).

559 The C-S-H decomposition by carbonation consists of the decalcification of the C-S-H gel with the
560 decrease of the Ca/Si ratio and can lead to a silicate polymerisation and to the formation of an
561 amorphous silica gel and calcium carbonates (Li et al., 2017; Sanjuán et al., 2018; Šavija and Luković,
562 2016; Steiner et al., 2020). Furthermore, it appears that the C-S-H decomposition increases with
563 decreasing Ca/Si ratio (Sevelsted and Skibsted, 2015). For extensive decalcification, the precipitation
564 of calcium carbonate polymorphs and the formation of a silica gel result in significant shrinkage, loss
565 of cohesion, increase in the number of pores and increased porosity (Li et al., 2017; Nedeljković et
566 al., 2018; Puertas et al., 2006; Sanjuán et al., 2018).

567 The use of GGBS as a supplementary material leads to a reduced portlandite content and a lower
568 Ca/Si ratio in the C-S-H gel (Lothenbach et al., 2011). Thus, the carbonation of slag cements leads to a
569 decrease of their micro-mechanical properties (Nedeljković et al., 2018) and to the coarsening of
570 their pore structure (Ngala and Page, 1997; Šavija and Luković, 2016). Several authors have reported
571 extensive cracking and increases of the chloride diffusion coefficient and the oxygen permeability
572 with carbonation on blended cements (Borges et al., 2010; Ngala and Page, 1997).

573 Under these CO₂-rich conditions, CEM III cement based matrices, well-known for their interesting
574 performances against acid attacks (Bertron et al., 2005b; Gruyaert et al., 2012; Oueslati and
575 Duchesne, 2014) or in mainly acidic environments (Koenig and Dehn, 2016), seem more sensitive to
576 the aggressiveness of this environment than CEM I cement pastes do, as portlandite is present in
577 lower quantities in the CEM III pastes and does not play its role of a sacrificial phase generating
578 calcium carbonates via its reaction with CO₂. The C(-A)-S-H are thus attacked, which damages the
579 paste. The carbonation may have increased the porosity of the CEM III pastes and induced a greater
580 penetration of aggressive agents into the sample, which could explain the chemical and mineralogical
581 changes highlighted above and also the deeper penetration of phosphorous from the liquid fraction
582 into the material. Significant carbonation followed by acidification cycles could also have weakened
583 the material.

584 4.3.2 MKAA

585 MKAA pastes showed only a very low degraded zone over the last hundreds of microns, as in the
586 previous study by Giroudon et al. (2021a) with cattle manure, and despite more aggressive
587 conditions in terms of acid concentrations and CO₂ flow. The chemical profiles highlighted the
588 dissolution of the matrix (Si, Al, Fe, Na), which has already been identified during acid attacks in other
589 studies (Bakharev, 2005; Burciaga-Díaz and Escalante-García, 2012; Ukrainczyk and Vogt, 2020). Thus,
590 in the case of MKAA, the acid attack seems to have a predominant effect. According to Burciaga-Díaz
591 and Escalante-García (2012), the deterioration of the paste in an acidic environment is due to the
592 destruction of the geopolymeric structure and the release of Na, Al and Si into the solution. Several
593 authors (Bakharev, 2005; Burciaga-Díaz and Escalante-García, 2012) agree that it causes the
594 breakdown of the aluminosilicate network of geopolymers. Nevertheless, in this environment, the
595 MKAA did not show any sign of intense cracks or lack of mechanical strength and showed really
596 interesting behaviour.

597 **5 Conclusion**

598 This study investigated the biogeochemical interactions between fermenting broken maize and
599 binder materials intended for anaerobic digester structures. Four types of binder materials were
600 inserted into reactors inoculated with broken maize during five consecutive cycles of anaerobic
601 digestion (245 days). The presence of the cement pastes CEM I, CEM III and CAC did not influence the
602 AD bioprocess in terms of pH, production of VFA and NH₄⁺ ions, production of CH₄ nor did it influence
603 microbial populations. CEM I and CEM III pastes nevertheless experienced biodegradation, with
604 phenomena of decalcification, carbonation and enrichment in P₂O₅ on the surface. The CEM III paste
605 generated a different zonation and a greater modified depth at the end of the experiment, which
606 was probably linked to the high sensitivity of the slags when exposed to carbonation.

607 In contrast, alkali-activated metakaolin-based geopolymer showed better behaviour when faced with
608 the aggressive environmental conditions, and exhibited a small modified depth, with a thickness of

609 several hundred micrometres only at the end of the experiment. The presence of this material led to
610 very low NH_4^+ concentrations, probably due to these adsorption capacities, which could be beneficial
611 for the treatment of nitrogen-rich biowaste. Moreover, the presence of the geopolymer resulted in a
612 different microbial population (absence of the genera *Methanobacterium* and *Aminomonas*) and a
613 slightly higher pH, although the CH_4 production was similar to that of other BMP reactors. Finally,
614 differences were observed between sessile and planktonic populations in all BMP reactors, with
615 more acidogens in the biofilm, mainly members of the genus *Clostridium*. The main difference
616 observed was a greater presence of acidogens within the depth of the biofilm, especially members of
617 the genus *Clostridium*, which were frequently encountered in the strongly adhered biofilm formed on
618 all the materials.

619

620 **CRedit authorship contribution statement**

621 Marie Giroudon: Conceptualization; Methodology; Investigation; Validation; Writing - Original Draft;
622 Writing - Review & Editing; Visualization

623 Cédric Perez: Conceptualization; Methodology; Investigation; Validation; Formal analysis; Writing -
624 Original Draft; Writing - Review & Editing; Visualization

625 Matthieu Peyre Lavigne: Conceptualization; Methodology; Investigation; Resources; Writing - Review
626 & Editing; Supervision

627 Benjamin Erable: Conceptualization; Methodology; Resources; Writing - Review & Editing;
628 Supervision

629 Christine Lors: Conceptualization; Methodology; Writing - Review & Editing; Supervision

630 Cédric Patapy: Conceptualization; Methodology; Resources; Writing - Review & Editing; Supervision

631 Alexandra Bertron: Conceptualization; Methodology; Resources; Writing - Review & Editing;
632 Supervision; Project administration; Funding acquisition

633 **Declaration of competing interest**

634 The authors declare that they know of no competing financial interests or personal relationships that
635 could have influenced the work reported in this paper.

636

637

638 **Acknowledgements**

639 The authors wish to thank the French National Research Agency (ANR) for funding the project
640 BIBENDOM – ANR – 16 – CE22 – 001 DS0602. The authors also thank Evrard Mengelle, Simon Dubos,
641 Mansour Bounouba and Chantha Kim for the design of the pilot and the analytical support for the
642 BMP reactors.

643

644 **References**

- 645 AFNOR, 2016. NF EN 196-1. Méthodes d'essais des ciments - Partie 1 : détermination des résistances.
646 Paris, France.
- 647 AFNOR, 2010. NF P18-459. Concrete - Testing hardened concrete - Testing porosity and density.
648 Paris, France.
- 649 Baena, S., Garcia, J.-L., Cayol, J.-L., Ollivier, B., 2015. Aminomonas, in: Bergey's Manual of Systematics
650 of Archaea and Bacteria. American Cancer Society, pp. 1–6.
651 <https://doi.org/10.1002/9781118960608.gbm01251>
- 652 Bakharev, T., 2005. Resistance of geopolymer materials to acid attack. Cem. Concr. Res. 35, 658–670.
653 <https://doi.org/10.1016/j.cemconres.2004.06.005>
- 654 Baroghel-Bouny, V., Capra, B., Laurens, D., 2008. La durabilité des armatures et du béton d'enrobage,
655 in: La Durabilité des Bétons. pp. 303–385.
- 656 Batstone, D.J., Keller, J., Angelidaki, I., Kalyuzhnyi, S.V., Pavlostathis, S.G., Rozzi, A., Sanders, W.T.M.,
657 Siegrist, H., Vavilin, V.A., 2002. The IWA Anaerobic Digestion Model No 1 (ADM1). Water Sci.
658 Technol. 45, 65–73.
- 659 Bertron, A., Duchesne, J., 2013. Attack of Cementitious Materials by Organic Acids in Agricultural and
660 Agrofood Effluents, in: Performance of Cement-Based Materials in Aggressive Aqueous

661 Environments, RILEM State-of-the-Art Reports. Springer, Dordrecht, pp. 131–173.
662 https://doi.org/10.1007/978-94-007-5413-3_6

663 Bertron, A., Duchesne, J., Escadeillas, G., 2007a. Durability of various binders exposed to organic
664 acids in manure. Presented at the Seventh CANMET/ACI International Conference on
665 Durability of Concrete, Montreal.

666 Bertron, A., Duchesne, J., Escadeillas, G., 2007b. Degradation of cement pastes by organic acids.
667 *Mater. Struct.* 40, 341–354. <https://doi.org/10.1617/s11527-006-9110-3>

668 Bertron, A., Duchesne, J., Escadeillas, G., 2005a. Accelerated tests of hardened cement pastes
669 alteration by organic acids: analysis of the pH effect. *Cem. Concr. Res.* 35, 155–166.
670 <https://doi.org/10.1016/j.cemconres.2004.09.009>

671 Bertron, A., Duchesne, J., Escadeillas, G., 2005b. Attack of cement pastes exposed to organic acids in
672 manure. *Cem. Concr. Compos.* 27, 898–909.
673 <https://doi.org/10.1016/j.cemconcomp.2005.06.003>

674 Bertron, A., Escadeillas, G., de Parseval, P., Duchesne, J., 2009. Processing of electron microprobe
675 data from the analysis of altered cementitious materials. *Cem. Concr. Res.* 39, 929–935.
676 <https://doi.org/10.1016/j.cemconres.2009.06.011>

677 Bertron, A., Escadeillas, G., Duchesne, J., 2004. Cement pastes alteration by liquid manure organic
678 acids: chemical and mineralogical characterization. *Cem. Concr. Res.* 34, 1823–1835.
679 <https://doi.org/10.1016/j.cemconres.2004.01.002>

680 Bertron, A., Peyre Lavigne, M., Patapy, C., Erable, B., 2017. Biodeterioration of concrete in
681 agricultural, agro-food and biogas plants: state of the art and challenges. *RILEM Tech. Lett.* 2,
682 83–89. <https://doi.org/10.21809/rilemtechlett.2017.42>

683 Board, E., 2015. Synergistaceae, in: *Bergey's Manual of Systematics of Archaea and Bacteria*.
684 American Cancer Society, pp. 1–1. <https://doi.org/10.1002/9781118960608.fbm00243>

685 Board, T.E., 2015. Petrimonas, in: *Bergey's Manual of Systematics of Archaea and Bacteria*. American
686 Cancer Society, pp. 1–2. <https://doi.org/10.1002/9781118960608.gbm00245>

687 Bond, T., Templeton, M.R., 2011. History and future of domestic biogas plants in the developing
688 world. *Energy Sustain. Dev.* 15, 347–354. <https://doi.org/10.1016/j.esd.2011.09.003>

689 Borges, P.H.R., Costa, J.O., Milestone, N.B., Lynsdale, C.J., Streatfield, R.E., 2010. Carbonation of CH
690 and C–S–H in composite cement pastes containing high amounts of BFS. *Cem. Concr. Res.* 40,
691 284–292. <https://doi.org/10.1016/j.cemconres.2009.10.020>

692 Bosshard, P.P., 2015. Turicibacter, in: *Bergey's Manual of Systematics of Archaea and Bacteria*.
693 American Cancer Society, pp. 1–2. <https://doi.org/10.1002/9781118960608.gbm00766>

694 Bruni, E., Jensen, A.P., Pedersen, E.S., Angelidaki, I., 2010. Anaerobic digestion of maize focusing on
695 variety, harvest time and pretreatment. *Appl. Energy* 87, 2212–2217.
696 <https://doi.org/10.1016/j.apenergy.2010.01.004>

697 Burciaga-Díaz, O., Escalante-García, J.I., 2012. Strength and Durability in Acid Media of Alkali Silicate-
698 Activated Metakaolin Geopolymers. *J. Am. Ceram. Soc.* 95, 2307–2313.
699 <https://doi.org/10.1111/j.1551-2916.2012.05249.x>

700 Chambre d'Agriculture, 2010. La méthanisation agricole, Fiche technique.

701 Drugă, B., Ukrainczyk, N., Weise, K., Koenders, E., Lackner, S., 2018. Interaction between wastewater
702 microorganisms and geopolymer or cementitious materials: Biofilm characterization and
703 deterioration characteristics of mortars. *Int. Biodeterior. Biodegrad.* 134, 58–67.
704 <https://doi.org/10.1016/j.ibiod.2018.08.005>

705 Duan, P., Yan, C., Zhou, W., Luo, W., Shen, C., 2015. An investigation of the microstructure and
706 durability of a fluidized bed fly ash–metakaolin geopolymer after heat and acid exposure.
707 *Mater. Des.* 74, 125–137. <https://doi.org/10.1016/j.matdes.2015.03.009>

708 Duchesne, J., Bertron, A., 2013. Leaching of Cementitious Materials by Pure Water and Strong Acids
709 (HCl and HNO₃), in: Alexander, M., Bertron, A., Belie, N.D. (Eds.), *Performance of Cement-
710 Based Materials in Aggressive Aqueous Environments*. Springer Netherlands, pp. 91–112.

711 Escadeillas, G., 2013. Ammonium Nitrate Attack on Cementitious Materials, in: Performance of
712 Cement-Based Materials in Aggressive Aqueous Environments, RILEM State-of-the-Art
713 Reports. Springer, Dordrecht, pp. 113–130. https://doi.org/10.1007/978-94-007-5413-3_5

714 Evans, G.M., Furlong, J.C., 2003. Environmental Biotechnology - Theory and Application. John Wiley &
715 Sons.

716 Galan, I., Glasser, F.P., Baza, D., Andrade, C., 2015. Assessment of the protective effect of
717 carbonation on portlandite crystals. *Cem. Concr. Res.* 74, 68–77.
718 <https://doi.org/10.1016/j.cemconres.2015.04.001>

719 Gerin, P.A., Vliegen, F., Jossart, J.-M., 2008. Energy and CO₂ balance of maize and grass as energy
720 crops for anaerobic digestion. *Bioresour. Technol.* 99, 2620–2627.
721 <https://doi.org/10.1016/j.biortech.2007.04.049>

722 Giroudon, M., Peyre Lavigne, M., Patapy, C., Bertron, A., 2021a. Blast-furnace slag cement and
723 metakaolin based geopolymer as construction materials for liquid anaerobic digestion
724 structures: Interactions and biodeterioration mechanisms. *Sci. Total Environ.* 750, 141518.
725 <https://doi.org/10.1016/j.scitotenv.2020.141518>

726 Giroudon, M., Peyre Lavigne, M., Patapy, C., Bertron, A., 2021b. Evaluation of the contribution of
727 chemical compounds to the degradation of Portland cement-based materials during
728 anaerobic digestion. *J. Environ. Manage.* Submitted.

729 Grengg, C., Ukrainczyk, N., Koraimann, G., Mueller, B., Dietzel, M., Mittermayr, F., 2020. Long-term in
730 situ performance of geopolymer, calcium aluminate and Portland cement-based materials
731 exposed to microbially induced acid corrosion. *Cem. Concr. Res.* 131, 106034.
732 <https://doi.org/10.1016/j.cemconres.2020.106034>

733 Gruyaert, E., Van den Heede, P., Maes, M., De Belie, N., 2012. Investigation of the influence of blast-
734 furnace slag on the resistance of concrete against organic acid or sulphate attack by means
735 of accelerated degradation tests. *Cem. Concr. Res.* 42, 173–185.
736 <https://doi.org/10.1016/j.cemconres.2011.09.009>

737 Han, J., Liang, Y., Sun, W., Liu, W., Wang, S., 2015. Microstructure Modification of Carbonated
738 Cement Paste with Six Kinds of Modern Microscopic Instruments. *J. Mater. Civ. Eng.* 27,
739 04014262. [https://doi.org/10.1061/\(ASCE\)MT.1943-5533.0001210](https://doi.org/10.1061/(ASCE)MT.1943-5533.0001210)

740 Holliger, C., Alves, M., Andrade, D., Angelidaki, I., Astals, S., Baier, U., Bougrier, C., Buffière, P.,
741 Carballa, M., de Wilde, V., Ebertseder, F., Fernández, B., Ficara, E., Fotidis, I., Frigon, J.-C., de
742 Lacos, H.F., Ghasimi, D.S.M., Hack, G., Hartel, M., Heerenklage, J., Horvath, I.S., Jenicek, P.,
743 Koch, K., Krautwald, J., Lizasoain, J., Liu, J., Mosberger, L., Nistor, M., Oechsner, H., Oliveira,
744 J.V., Paterson, M., Pauss, A., Pommier, S., Porqueddu, I., Raposo, F., Ribeiro, T., Rüscher, P.,
745 Strömberg, S., Torrijos, M., van Eekert, M., van Lier, J., Wedwitschka, H., Wierinck, I.,
746 2016. Towards a standardization of biomethane potential tests. *Water Sci. Technol.* 74,
747 2515–2522. <https://doi.org/10.2166/wst.2016.336>

748 Karthikeyan, O.P., Visvanathan, C., 2013. Bio-energy recovery from high-solid organic substrates by
749 dry anaerobic bio-conversion processes: a review. *Rev. Environ. Sci. Biotechnol.* 12, 257–284.
750 <https://doi.org/10.1007/s11157-012-9304-9>

751 Koenig, A., Dehn, F., 2016. Biogenic acid attack on concretes in biogas plants. *Biosyst. Eng.* 147, 226–
752 237. <https://doi.org/10.1016/j.biosystemseng.2016.03.007>

753 Krakat, N., Westphal, A., Schmidt, S., Scherer, P., 2010. Anaerobic Digestion of Renewable Biomass:
754 Thermophilic Temperature Governs Methanogen Population Dynamics. *Appl. Environ.
755 Microbiol.* 76, 1842–1850. <https://doi.org/10.1128/AEM.02397-09>

756 Langer, S., Schropp, D., Bengelsdorf, F.R., Othman, M., Kazda, M., 2014. Dynamics of biofilm
757 formation during anaerobic digestion of organic waste. *Anaerobe* 29, 44–51.
758 <https://doi.org/10.1016/j.anaerobe.2013.11.013>

759 Li, N., Farzadnia, N., Shi, C., 2017. Microstructural changes in alkali-activated slag mortars induced by
760 accelerated carbonation. *Cem. Concr. Res.* 100, 214–226.
761 <https://doi.org/10.1016/j.cemconres.2017.07.008>

762 Liu, Y., Whitman, W.B., 2008. Metabolic, Phylogenetic, and Ecological Diversity of the Methanogenic
763 Archaea. *Ann. N. Y. Acad. Sci.* 1125, 171–189. <https://doi.org/10.1196/annals.1419.019>

764 Lothenbach, B., Scrivener, K., Hooton, R.D., 2011. Supplementary cementitious materials. *Cem.*
765 *Concr. Res., Conferences Special: Cement Hydration Kinetics and Modeling*, Quebec City,
766 2009 & CONMOD10, Lausanne, 2010 41, 1244–1256.
767 <https://doi.org/10.1016/j.cemconres.2010.12.001>

768 Magniont, C., Coutand, M., Bertron, A., Cameleyre, X., Lafforgue, C., Beaufort, S., Escadeillas, G.,
769 2011. A new test method to assess the bacterial deterioration of cementitious materials.
770 *Cem. Concr. Res.* 41, 429–438. <https://doi.org/10.1016/j.cemconres.2011.01.014>

771 Meegoda, J., Li, B., Patel, K., Wang, L., 2018. A Review of the Processes, Parameters, and
772 Optimization of Anaerobic Digestion. *Int. J. Environ. Res. Public Health* 15, 2224.
773 <https://doi.org/10.3390/ijerph15102224>

774 Ministère de la transition écologique et solidaire, 2020. Programmation Pluriannuelle de l’Energie
775 2019 - 2024 - 2028 Stratégie française pour l’énergie et le climat - Projet pour
776 consultation.

777 Nathalie Bachmann, E.S.A., 2013. 8 - Design and engineering of biogas plants, in: Wellinger, A.,
778 Murphy, J., Baxter, D. (Eds.), *The Biogas Handbook*, Woodhead Publishing Series in Energy.
779 Woodhead Publishing, pp. 191–211. <https://doi.org/10.1533/9780857097415.2.191>

780 Nedeljković, M., Šavija, B., Zuo, Y., Luković, M., Ye, G., 2018. Effect of natural carbonation on the pore
781 structure and elastic modulus of the alkali-activated fly ash and slag pastes. *Constr. Build.*
782 *Mater.* 161, 687–704. <https://doi.org/10.1016/j.conbuildmat.2017.12.005>

783 Ngala, V.T., Page, C.L., 1997. Effects of carbonation on pore structure and diffusional properties of
784 hydrated cement pastes. *Cem. Concr. Res.* 27, 995–1007. [https://doi.org/10.1016/S0008-8846\(97\)00102-6](https://doi.org/10.1016/S0008-8846(97)00102-6)

785

786 Osborne, G.J., 1999. Durability of Portland blast-furnace slag cement concrete. *Cem. Concr. Compos.*
787 21, 11–21. [https://doi.org/10.1016/S0958-9465\(98\)00032-8](https://doi.org/10.1016/S0958-9465(98)00032-8)

788 Oueslati, O., Duchesne, J., 2014. Resistance of blended cement pastes subjected to organic acids:
789 Quantification of anhydrous and hydrated phases. *Cem. Concr. Compos.* 45, 89–101.
790 <https://doi.org/10.1016/j.cemconcomp.2013.09.007>

791 Oueslati, O., Duchesne, J., 2012. The effect of SCMs and curing time on resistance of mortars
792 subjected to organic acids. *Cem. Concr. Res.* 42, 205–214.
793 <https://doi.org/10.1016/j.cemconres.2011.09.017>

794 Perez, C., Lors, C., Floquet, P., Erable, B., 2021. Biodeterioration kinetics and microbial community
795 organization on surface of cementitious materials exposed to anaerobic digestion conditions.
796 *J. Environ. Chem. Eng.* 9, 105334. <https://doi.org/10.1016/j.jece.2021.105334>

797 Pouhet, R., 2015. Formulation and durability of metakaolin-based geopolymers (Thesis). Université
798 de Toulouse, Université Toulouse III - Paul Sabatier.

799 Pouhet, R., Cyr, M., Bucher, R., 2019. Influence of the initial water content in flash calcined
800 metakaolin-based geopolymer. *Constr. Build. Mater.* 201, 421–429.
801 <https://doi.org/10.1016/j.conbuildmat.2018.12.201>

802 Puertas, F., Palacios, M., Vázquez, T., 2006. Carbonation process of alkali-activated slag mortars. *J.*
803 *Mater. Sci.* 41, 3071–3082. <https://doi.org/10.1007/s10853-005-1821-2>

804 Sanjuán, M.Á., Estévez, E., Argiz, C., Barrio, D. del, 2018. Effect of curing time on granulated blast-
805 furnace slag cement mortars carbonation. *Cem. Concr. Compos.* 90, 257–265.
806 <https://doi.org/10.1016/j.cemconcomp.2018.04.006>

807 Šavija, B., Luković, M., 2016. Carbonation of cement paste: Understanding, challenges, and
808 opportunities. *Constr. Build. Mater.* 117, 285–301.
809 <https://doi.org/10.1016/j.conbuildmat.2016.04.138>

810 Schink, B., 2015. Pelospora, in: *Bergey’s Manual of Systematics of Archaea and Bacteria*. American
811 Cancer Society, pp. 1–4. <https://doi.org/10.1002/9781118960608.gbm00681>

812 Sekiguchi, Y., 2015. *Syntrophomonas*, in: Whitman, W.B., Rainey, F., Kämpfer, P., Trujillo, M., Chun, J.,
813 DeVos, P., Hedlund, B., Dedysh, S. (Eds.), *Bergey’s Manual of Systematics of Archaea and*

814 Bacteria. John Wiley & Sons, Ltd, Chichester, UK, pp. 1–11.
815 <https://doi.org/10.1002/9781118960608.gbm00682>

816 Sevelsted, T.F., Skibsted, J., 2015. Carbonation of C–S–H and C–A–S–H samples studied by ¹³C, ²⁷Al
817 and ²⁹Si MAS NMR spectroscopy. *Cem. Concr. Res.* 71, 56–65.
818 <https://doi.org/10.1016/j.cemconres.2015.01.019>

819 Shah, V., Scrivener, K., Bhattacharjee, B., Bishnoi, S., 2018. Changes in microstructure characteristics
820 of cement paste on carbonation. *Cem. Concr. Res.* 109, 184–197.
821 <https://doi.org/10.1016/j.cemconres.2018.04.016>

822 Singh, B., Ishwarya, G., Gupta, M., Bhattacharyya, S.K., 2015. Geopolymer concrete: A review of some
823 recent developments. *Constr. Build. Mater.* 85, 78–90.
824 <https://doi.org/10.1016/j.conbuildmat.2015.03.036>

825 Song, H., Clarke, W.P., Blackall, L.L., 2005. Concurrent microscopic observations and activity
826 measurements of cellulose hydrolyzing and methanogenic populations during the batch
827 anaerobic digestion of crystalline cellulose. *Biotechnol. Bioeng.* 91, 369–378.
828 <https://doi.org/10.1002/bit.20517>

829 Steiner, S., Lothenbach, B., Proske, T., Borgschulte, A., Winnefeld, F., 2020. Effect of relative humidity
830 on the carbonation rate of portlandite, calcium silicate hydrates and ettringite. *Cem. Concr.*
831 *Res.* 135, 106116. <https://doi.org/10.1016/j.cemconres.2020.106116>

832 Su, X.-L., Tian, Q., Zhang, J., Yuan, X.-Z., Shi, X.-S., Guo, R.-B., Qiu, Y.-L., 2014. *Acetobacteroides*
833 *hydrogenigenes* gen. nov., sp. nov., an anaerobic hydrogen-producing bacterium in the
834 family Rikenellaceae isolated from a reed swamp. *Int. J. Syst. Evol. Microbiol.* 64, 2986–2991.
835 <https://doi.org/10.1099/ijs.0.063917-0>

836 Thiery, M., Villain, G., Dangla, P., Platret, G., 2007. Investigation of the carbonation front shape on
837 cementitious materials: Effects of the chemical kinetics. *Cem. Concr. Res.* 37, 1047–1058.
838 <https://doi.org/10.1016/j.cemconres.2007.04.002>

839 Turlousse, D.M., Sekiguchi, Y., 2018. Flexilinea, in: *Bergey's Manual of Systematics of Archaea and*
840 *Bacteria.* American Cancer Society, pp. 1–4.
841 <https://doi.org/10.1002/9781118960608.gbm01551>

842 Ukrainczyk, N., Vogt, O., 2020. Geopolymer leaching in water and acetic acid. *RILEM Tech. Lett.* 5,
843 163–173. <https://doi.org/10.21809/rilemtechlett.2020.124>

844 Venkiteswaran, K., Bocher, B., Maki, J., Zitomer, D., 2015. Relating Anaerobic Digestion Microbial
845 Community and Process Function : Supplementary Issue: Water Microbiology. *Microbiol.*
846 *Insights* 8s2, MBI.S33593. <https://doi.org/10.4137/MBI.S33593>

847 Voegel, C., Bertron, A., Erable, B., 2016. Mechanisms of cementitious material deterioration in biogas
848 digester. *Sci. Total Environ.* 571, 892–901. <https://doi.org/10.1016/j.scitotenv.2016.07.072>

849 Voegel, C., Durban, N., Bertron, A., Landon, Y., Erable, B., 2020. Evaluation of microbial proliferation
850 on cementitious materials exposed to biogas systems. *Environ. Technol.* 41, 2439–2449.
851 <https://doi.org/10.1080/09593330.2019.1567610>

852 Voegel, C., Giroudon, M., Bertron, A., Patapy, C., Peyre Lavigne, M., Verdier, T., Erable, B., 2019.
853 Cementitious materials in biogas systems: Biodeterioration mechanisms and kinetics in CEM I
854 and CAC based materials. *Cem. Concr. Res.* 124, 105815.
855 <https://doi.org/10.1016/j.cemconres.2019.105815>

856 Yoon, S.S., Hennigan, R.F., Hilliard, G.M., Ochsner, U.A., Parvatiyar, K., Kamani, M.C., Allen, H.L.,
857 DeKievit, T.R., Gardner, P.R., Schwab, U., Rowe, J.J., Iglewski, B.H., McDermott, T.R., Mason,
858 R.P., Wozniak, D.J., Hancock, R.E.W., Parsek, M.R., Noah, T.L., Boucher, R.C., Hassett, D.J.,
859 2002. *Pseudomonas aeruginosa* Anaerobic Respiration in Biofilms: Relationships to Cystic
860 Fibrosis Pathogenesis. *Dev. Cell* 3(4), 593–603.

863 **Supplementary material**

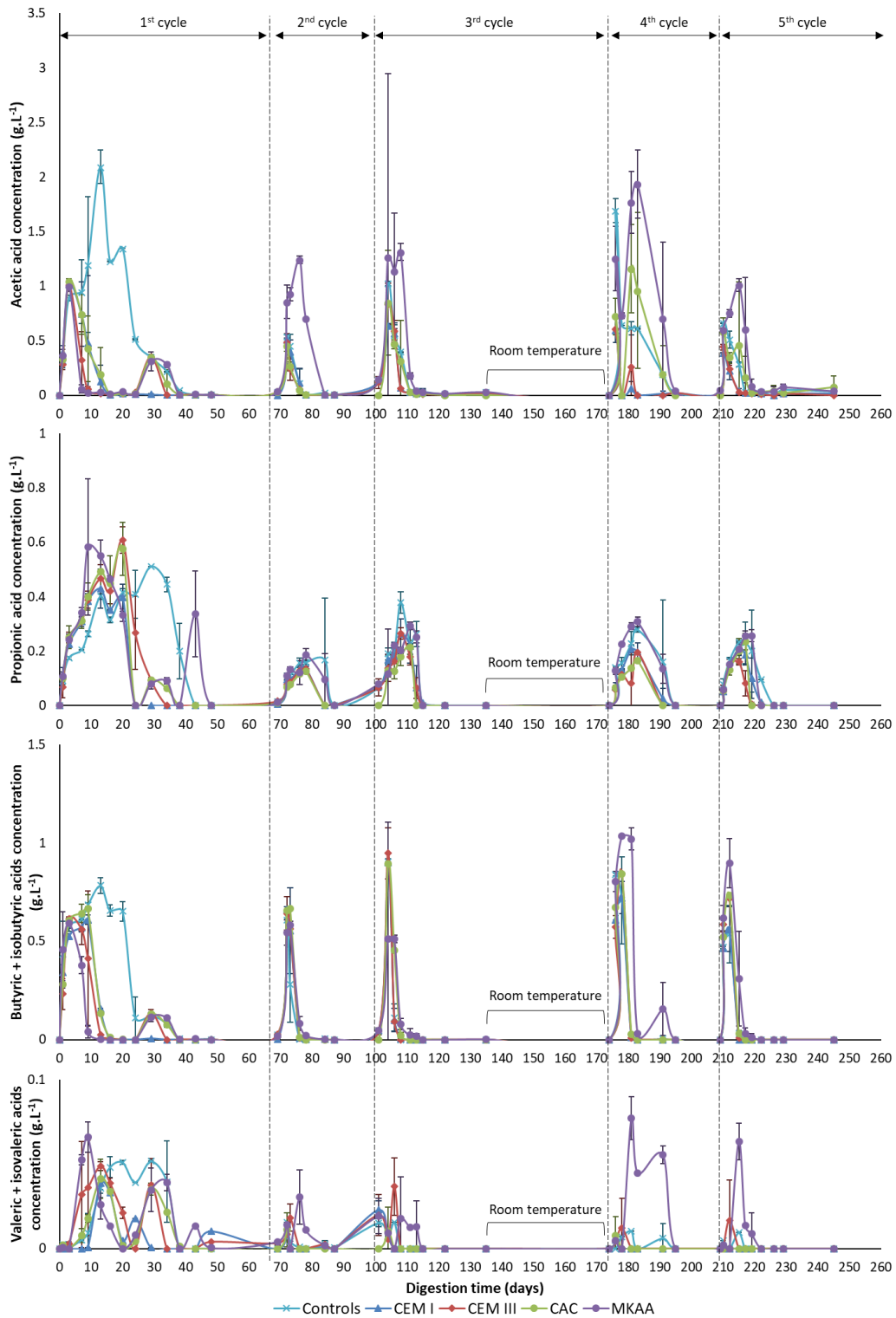

864

865 *Appendix A: Evolution of the VFA concentrations during the five cycles of AD in the BMP reactors, with or without binder*
 866 *materials. Mean values of the two duplicate BMP reactors are presented with the standard deviations.*

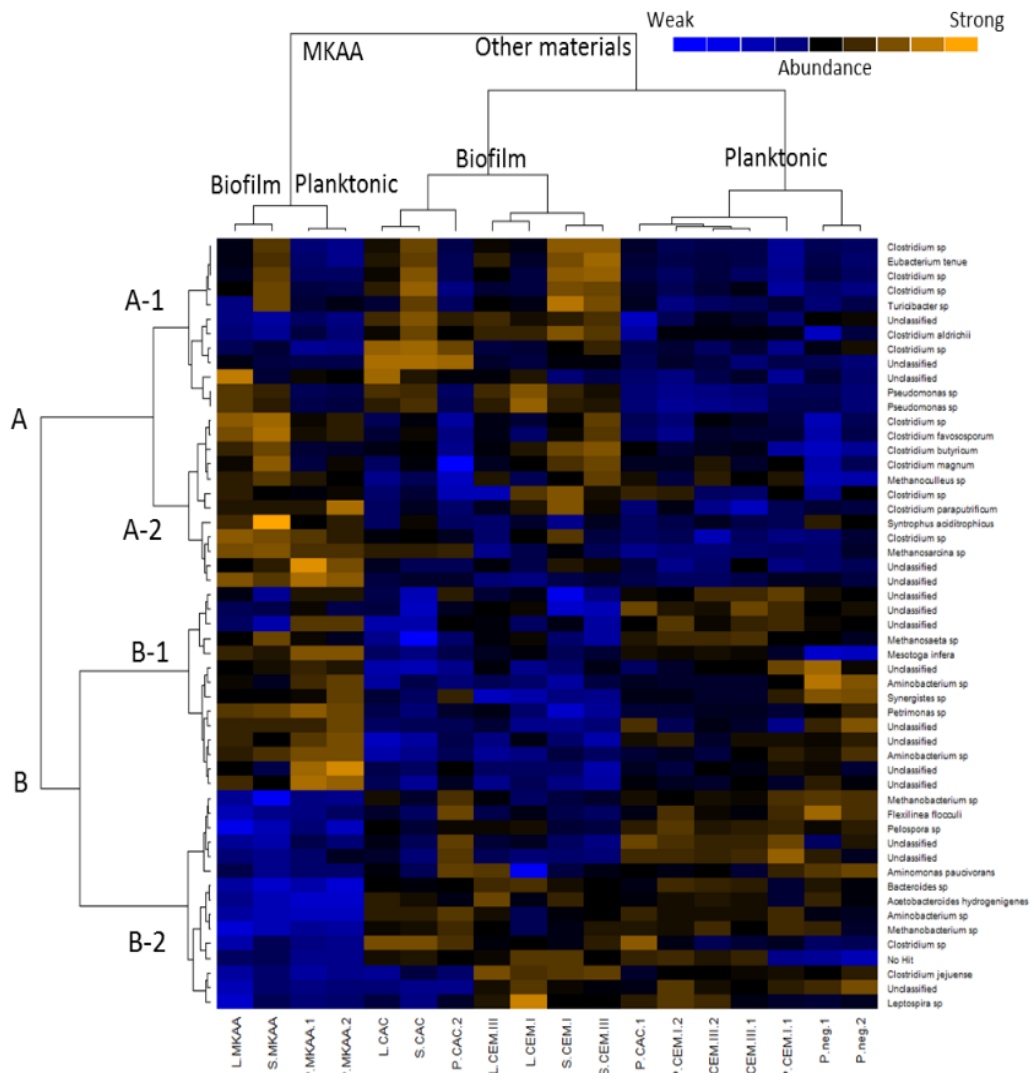

867

868 *Appendix B: Heatmap with colour scale of the next generation sequencing of the 16S DNA from planktonic biomass samples*
 869 *and "poorly" and "strongly" adhered biomass taken from the surface of cementitious material samples and after 5 cycles of*
 870 *anaerobic digestion – L: weakly adhered biofilm; S: Strongly adhered biofilm; P: Planktonic; only OTUs with an abundance of*
 871 *at least 1% in at least one sample are shown*

872

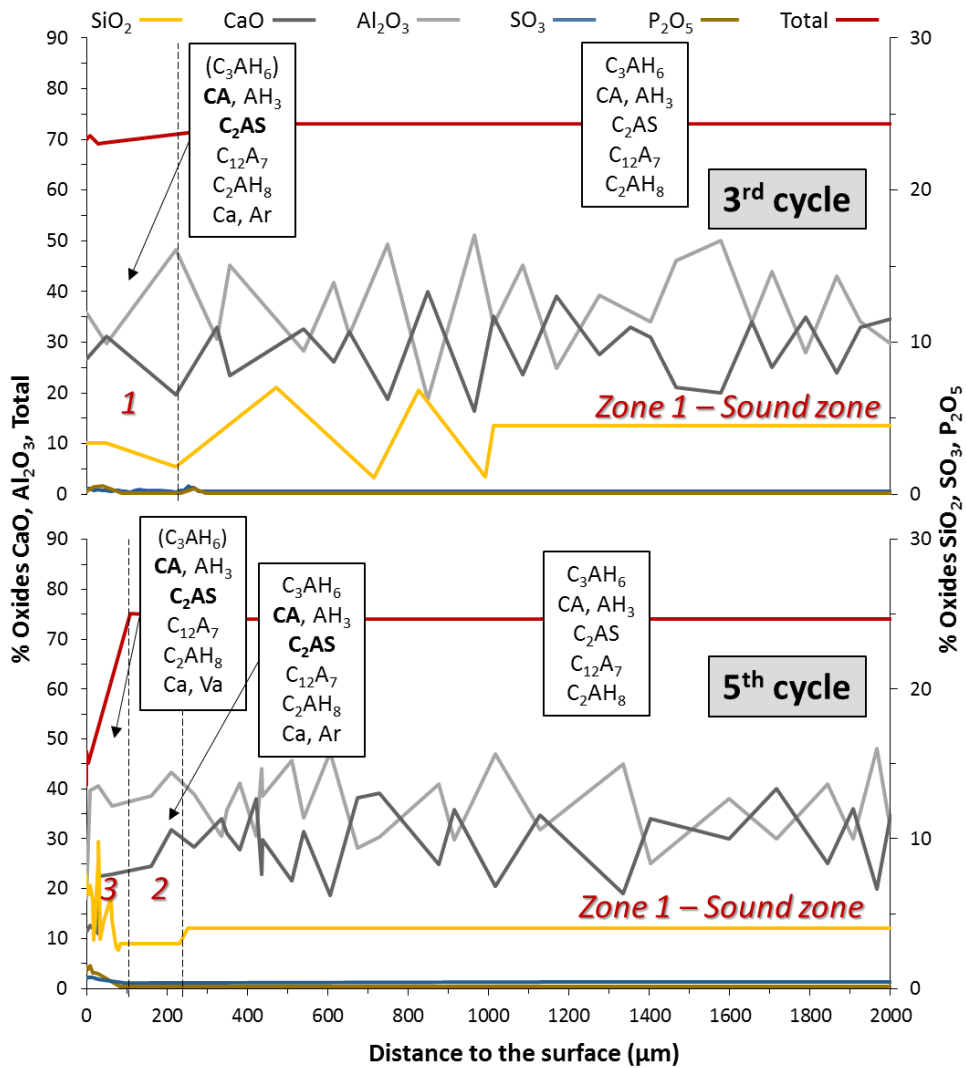

873

874 Appendix C: Chemical (EPMA) and mineralogical (XRD) changes in the CAC pastes after 3 and 5 cycles of anaerobic digestion
 875 of broken maize – Ca: calcite; Ar: aragonite – Bold characters = intensification of the XRD signal in comparison with the
 876 deeper zone; Parentheses = significantly lower intensity of the XRD signal in comparison with the main phase

877

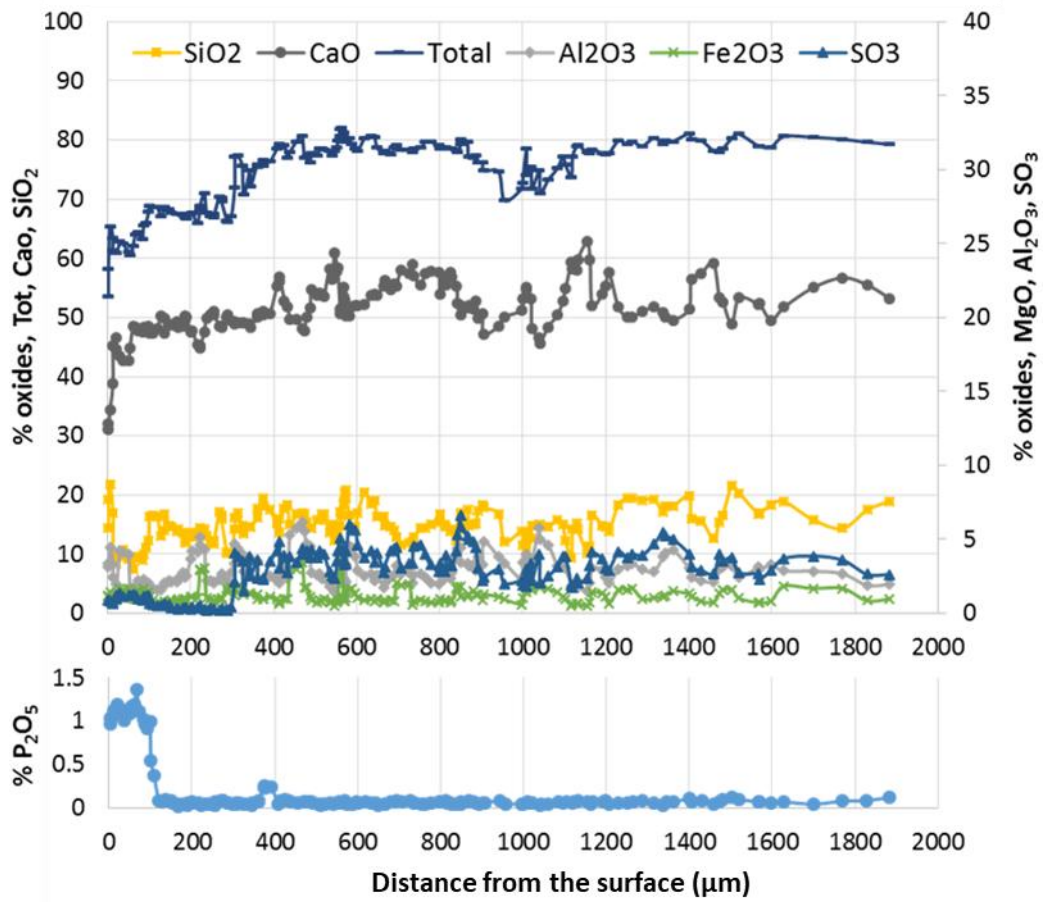

878

879 *Appendix D: Chemical composition profile (EPMA), according to the distance from the surface, of the CEM I paste after 5*
 880 *cycles in the broken maize in digestion*

881

CH: Portlandite (PDF 44-1481)
 Et: Ettringite (PDF 41-1451)
 Ca: Calcite (PDF 05-0586)
 Va: Vaterite (PDF 33-0268)

C₃S: Hatrurite (PDF 86-0402) & Calcium silicate (PDF 42-0551)
 C₂S: Larnite (PDF 29-0371)
 C₃A: Tricalcium aluminate (PDF 38-1429)
 Br: Brownmillerite (PDF 30-0226)

External zone

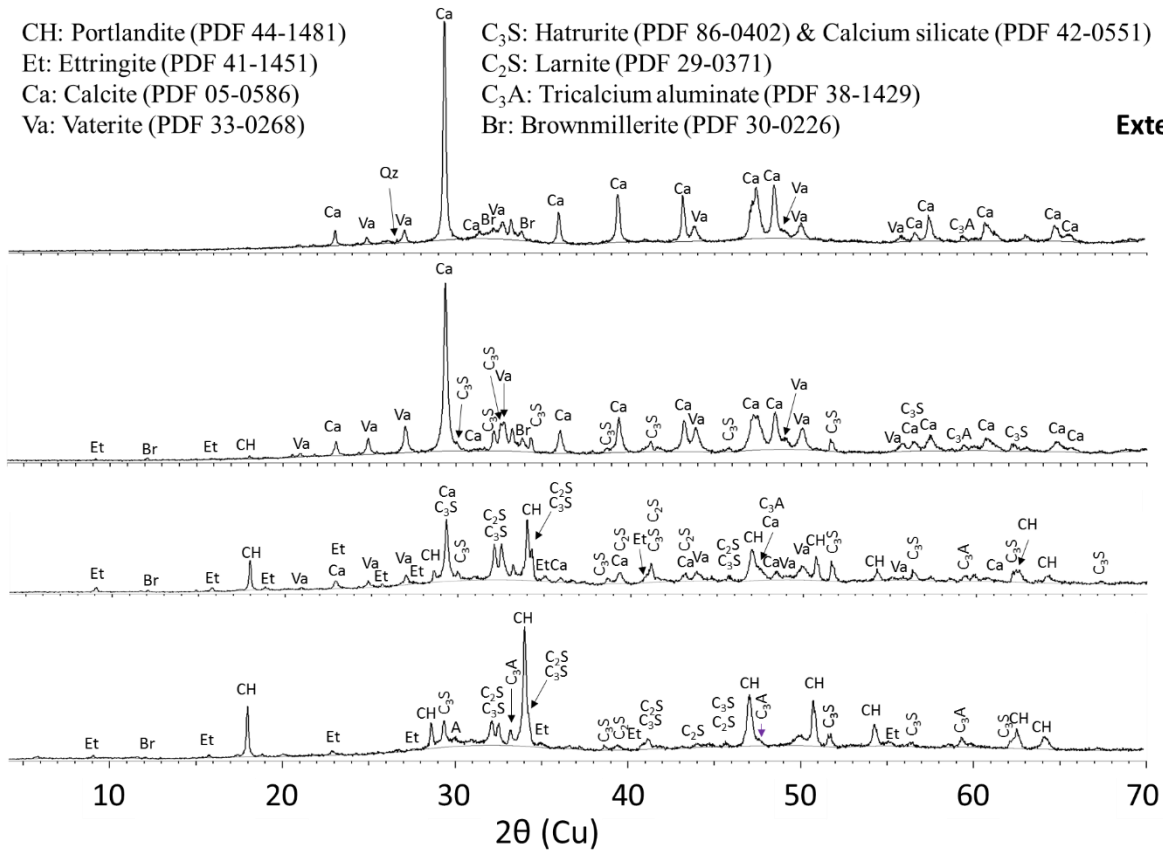

882

883 *Appendix E: Mineralogical analyses of the CEM I paste after 5 cycles in the fermenting broken maize*

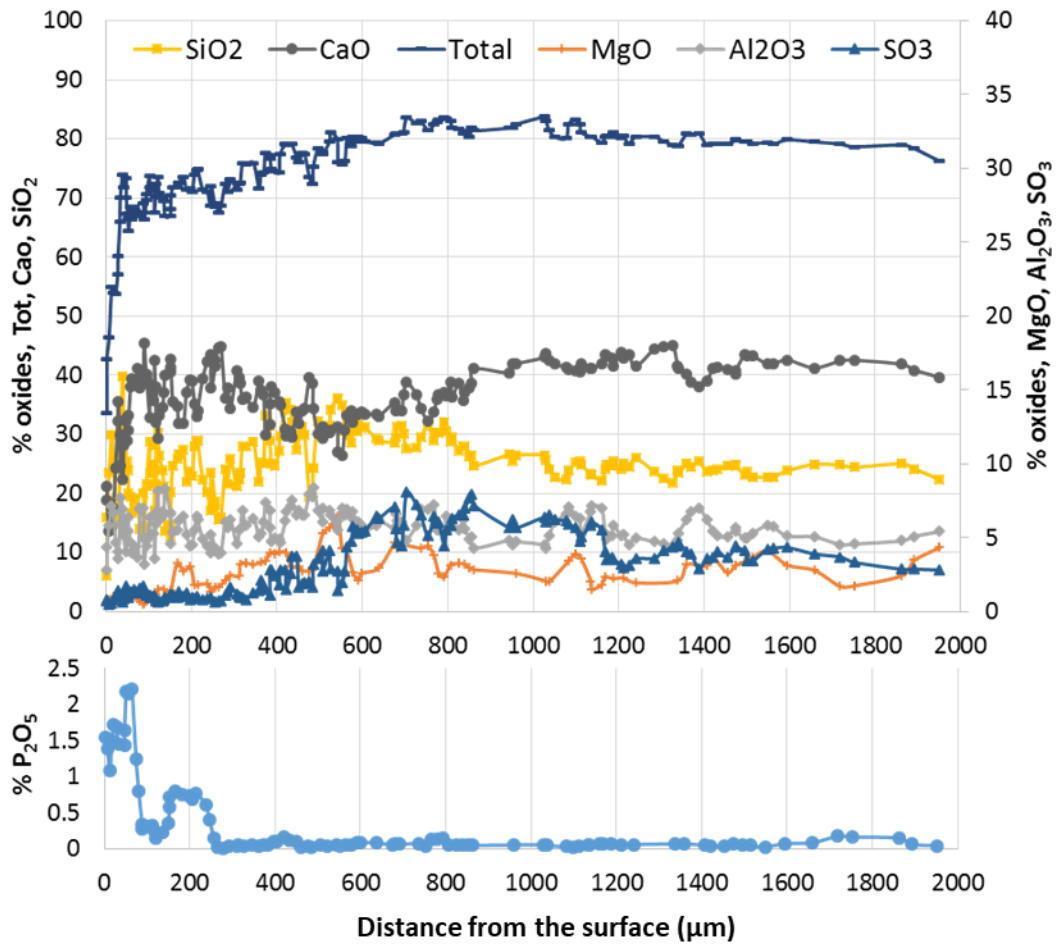

884

885 *Appendix F: Chemical composition profile (EPMA), according to the distance from the surface, of the CEM III paste after 5*
 886 *cycles in the fermenting broken maize*

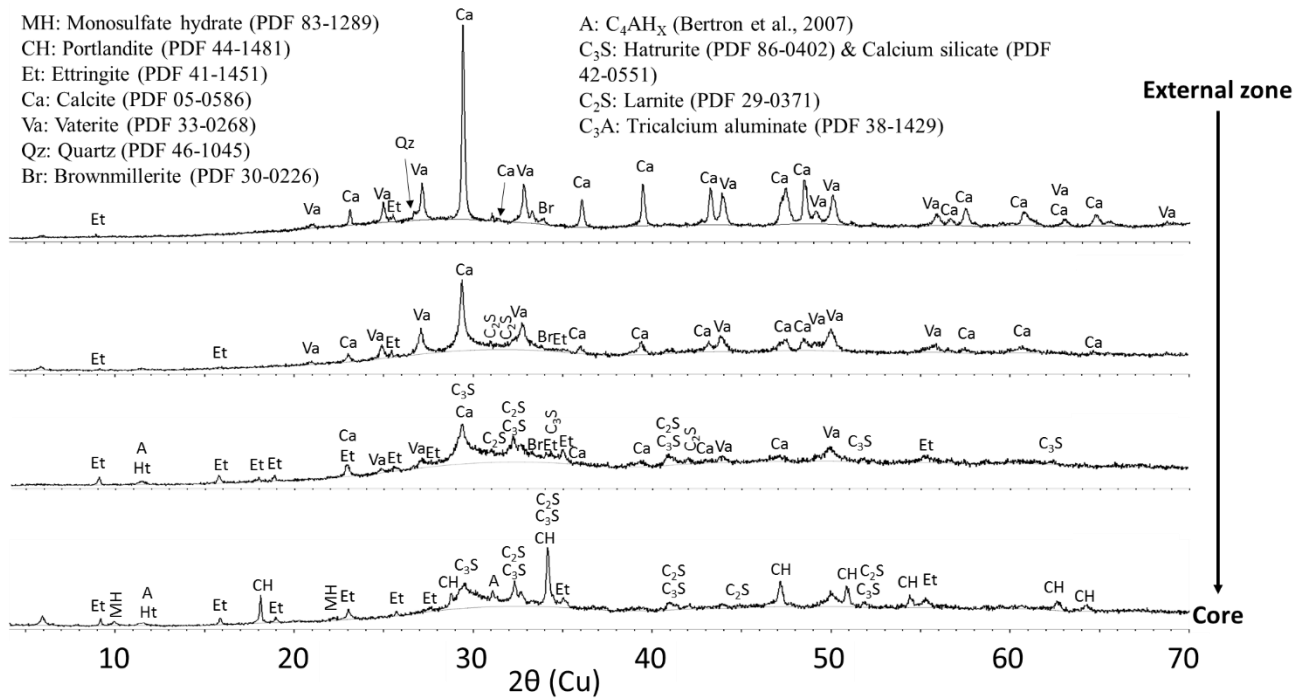

887

888 *Appendix G: Mineralogical analyses of the CEM III paste after 5 cycles in the fermenting broken maize, C_4AH_x identification*
 889 *from Bertron et al. (2007b)*

890

891 RT-LABS Amplification and Sequencing protocol

892 Illumina 2-step

893 Samples were amplified for sequencing in a two-step process. The forward primer was constructed
 894 (5'-3') with the forward Illumina overhang adapter (TCGTCGGCAGCGTCAGATGTGTATAAGAGACAG)
 895 added to the 515F primer (GTGCCAGCMGCCGCGGTAA). The reverse primer was constructed (5'-3')
 896 with the reverse Illumina overhang adapter (GTCTCGTGGGCTCGGAGATGTGTATAAGAGACAG) added
 897 to the 806R primer (GGACTACHVGGGTWTCTAAT). Amplifications were performed in 25 μ L reactions
 898 with Qiagen HotStar Taq master mix (Qiagen Inc., Valencia, California), 1 μ L of each 5 μ M primer and
 899 1 μ L of template. Reactions were performed on ABI Veriti thermocyclers (Applied Biosystems,
 900 Carlsbad, California) under the following thermal profile: 95 $^{\circ}$ C for 5 min, then 35 cycles of 94 $^{\circ}$ C for
 901 30 s, 54 $^{\circ}$ C for 40 s, 72 $^{\circ}$ C for 1 min, followed by one cycle of 72 $^{\circ}$ C for 10 min and 4 $^{\circ}$ C hold.

902 Products from the first stage amplification were added to a second PCR based on qualitatively
903 determined concentrations. Primers for the second PCR were designed based on the Illumina
904 Nextera PCR primers as follows: Forward -
905 AATGATACGGCGACCACCGAGATCTACAC[i5index]TCGTCCGCAGCGTC and Reverse -
906 CAAGCAGAAGACGGCATAACGAGAT[i7index]GTCTCGTGGGCTCGG. The second stage amplification was
907 run in the same way as the first stage except for 10 cycles.

908 Amplification products were visualized with eGels (Life Technologies, Grand Island, New York).
909 Products were then pooled at equimolar ratios and each pool was size selected in two rounds using
910 SPRIselect Reagent (BeckmanCoulter, Indianapolis, Indiana) in a 0.75 ratio for both rounds. Size
911 selected pools were then quantified using the Qubit 4 Fluorometer (Life Technologies) and loaded on
912 an Illumina MiSeq (Illumina, Inc. San Diego, California) 2x300 flow cell at 10 pM.

913

914